



16° RALLY
TEHUACÁN, PUE.

SIERRAS DEL SUR

2 Y 3 DE JUNIO DEL 2023

FEMADACH CNRM UNIVERSIDAD Mesoamericana CEMAC PAC

LIBRETA DE RUTA





ITINERARIO 16° RALLY SIERRAS DEL SUR 2023



VIERNES 2 DE JUNIO 2023

TC/CH	LOCALIZACION	DIST. TC	DIST. TRANS.	DIST. TOTAL	TIEMPO PARCIAL	HORA 1er. AUTO
PC0	SALIDA CEREMONIAL McCARTHY'S TEHUACÁN	0.000	0.000	0.000	00:00	20:00

SABADO 3 DE JUNIO 2023

TC/CH	LOCALIZACION	DIST. TC	DIST. TRANS.	DIST. TOTAL	TIEMPO PARCIAL	HORA 1er. AUTO
PC1	PARQUE CERRADO DE INICIO CENTRO ZAPOTITLAN SALINAS					08:30
0	SALIDA EN CENTRO ZAPOTITLAN SALINAS					09:00
1			30.340	30.340	00:30	09:30
TC1	TRUJAPAN 1	12.450				09:33
2			29.590	42.040	01:00	10:33
TC2	TRUJAPAN 2	12.450				10:36
3			13.450	25.900	00:53	11:29
TC3	SANTO DOMINGO 1	14.700				11:32
3A	ENTRADA A SERVICIO		1.800	16.500	00:20	11:52
SERVICIO A						00:45
TOTAL SECCION 1		39.600	75.180	114.780		
3B	SALIDA DE SERVICIO - ENTRADA RECLASIFICACIÓN					12:37
3C	SALIDA DE RECLASIFICACION				00:15	12:52
4			2.020	2.020	00:03	12:55
TC4	OLLERAS 1	15.500				12:58
5			12.560	28.060	00:36	13:34
TC5	ATZUMBA 1	12.450				13:37
6			29.650	42.100	01:20	14:57
TC6	ATZUMBA 2	12.450				15:00
7			30.390	42.840	00:45	15:45
TC7	SANTO DOMINGO 2	14.700				15:48
7A	ENTRADA A SERVICIO		1.800	16.500	00:20	16:08
SERVICIO B						00:45
TOTAL SECCION 2		55.100	76.420	131.520		
7B	SALIDA DE SERVICIO - ENTRADA RECLASIFICACIÓN					16:53
7C	SALIDA DE RECLASIFICACION				00:15	17:08
8			2.020	2.020	00:03	17:11
TC8	OLLERAS 2 Power Stage	15.500				17:14
8A	META McCARTHY'S TEHUACÁN		63.550	79.050	01:20	18:34
TOTAL SECCION 3		15.500	65.570	81.070		
TOTAL DEL EVENTO =		110.200	217.170	327.370		

1ra Sección

2da Sección



3era Sección



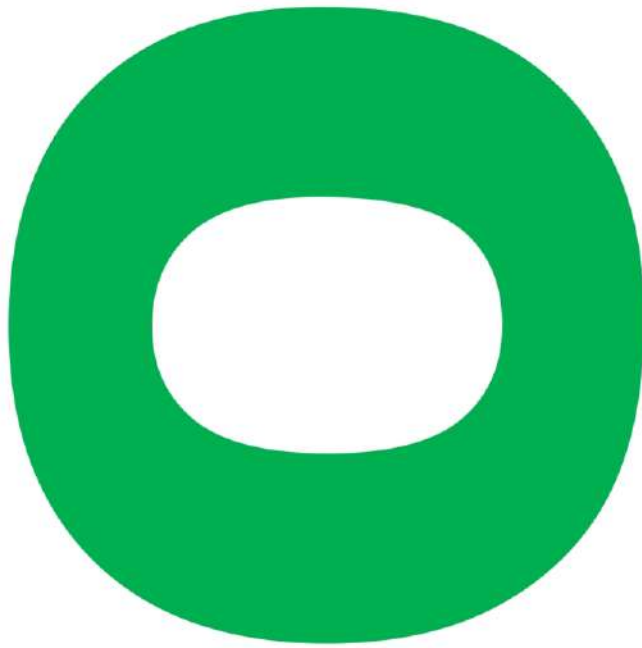

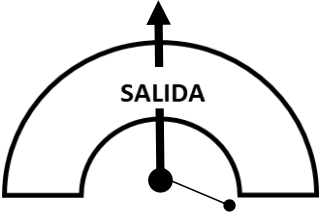

TC CH TC CH	0	SALIDA CENTRO DE ZAPOTITLAN	DISTANCIA	0
	1	TRUJAPAN 1	30.340	
			PROMEDIO-AVERAGE	TIEMPO TIME 00:30
			60.68 km/h	

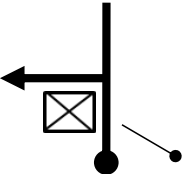
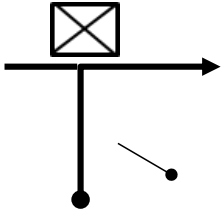
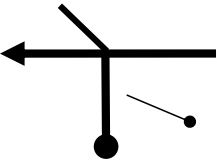
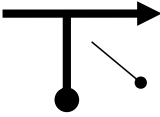
DISTANCIA		DIRECCIÓN DIRECTION	PAV	INFORMACIÓN INFORMATION	DIST. REG.
TOTAL	PARCIAL				TO GO
0.000	0.000			 CONTROL "CH" SALIDA PARQUE CERRADO SOBRE CALLE CRUZ VERDE	30.340
0.030	0.030			A LA IZQUIERDA SOBRE CALLE ALLENDE (PARQUE)	30.310
0.610	0.580			A LA DERECHA POR CALLE HIDALGO PONIENTE	29.730
0.632	0.022			A LA IZQUIERDA POR CALLE NACIONAL SUR	29.708
0.951	0.319			A LA DERECHA CON PRECAUCIÓN ENTRONQUE CON CARRETERA !	29.389

DISTANCIA A LA PRÓXIMA INSTRUCCIÓN	0.159
------------------------------------	-------

TC CH	0	SALIDA CENTRO DE ZAPOTITLAN	DISTANCIA	0
	1	TRUJAPAN 1	30.340	
TC CH			PROMEDIO-AVERAGE	TIEMPO TIME
			60.68 km/h	00:30

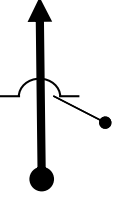
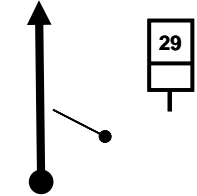
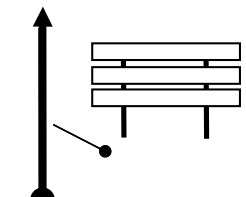
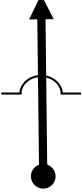
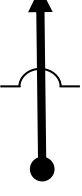
DISTANCIA		DIRECCIÓN DIRECTION	PAV	INFORMACIÓN INFORMATION	DIST. REG. TO GO
TOTAL	PARCIAL				
1.110	0.159			TOPE	29.230
		6			
2.150	1.040			KM. 29	28.190
		7			
6.150	4.000			DE FRENTE LETRERO TRIPLE TEHUACAN SAN JUAN RAYA SANTA ANA TELOXTOC	24.190
		8			
10.000	3.850			TOPES (3)	20.340
		9			
20.200	10.200			TOPES (2)	10.140
		10			

DISTANCIA A LA PRÓXIMA INSTRUCCIÓN	0.380
------------------------------------	-------

16o. RALLY SIERRAS DEL SUR

www.cnrm.com.mx



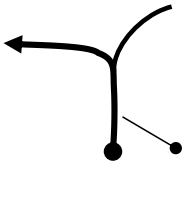
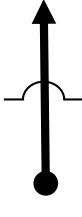
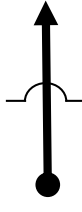
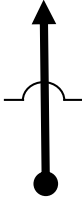
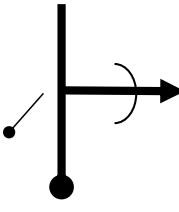

2

TC CH	0	SALIDA CENTRO DE ZAPOTITLAN	DISTANCIA	0
	1	TRUJAPAN 1	30.340	
TC CH			PROMEDIO-AVERAGE	TIEMPO TIME
			60.68 km/h	00:30

DISTANCIA		DIRECCIÓN DIRECTION	PAV	INFORMACIÓN INFORMATION	DIST. REG. TO GO
TOTAL	PARCIAL				
20.580	0.380			POR LA IZQUIERDA HACIA CALTEPEC PRECAUCION	9.760
20.680	0.100			TOPE (3)	9.660
23.000	2.320			TOPE (2)	7.340
24.440	1.440			TOPE (2)	5.900
24.800	0.360			A LA DERECHA A ATZUMBA Y TOPE	5.540

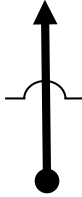
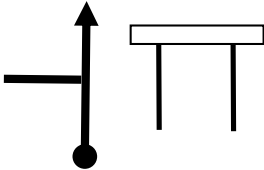

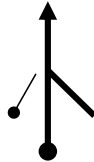

DISTANCIA A LA PRÓXIMA INSTRUCCIÓN	0.050
------------------------------------	-------

TC CH	0	SALIDA CENTRO DE ZAPOTITLAN	DISTANCIA	0
	1	TRUJAPAN 1	30.340	
TC CH			PROMEDIO-AVERAGE	TIEMPO TIME 00:30
			60.68 km/h	

DISTANCIA		DIRECCIÓN DIRECTION	PAV	INFORMACIÓN INFORMATION	DIST. REG. TO GO
TOTAL	PARCIAL				
24.850	0.050			TOPE (2)	5.490
		16			
29.290	4.440			LETRERO SAN PABLO DE FRENTE	1.050
		17			
30.290	1.000			 CONTROL "CH" MARCA EN PISO L.D.	0.050
		18			
30.340	0.050			 CONTROL "A" MARCA EN PISO BARDA DE PIEDRA L.I. 18°10'02.3"N 97°34'24.8"W	0.000
		19			

DISTANCIA A LA PRÓXIMA INSTRUCCIÓN	0.000
------------------------------------	-------

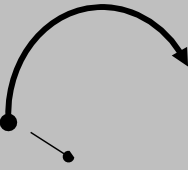
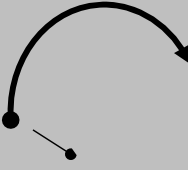
SS TC TC CH	1	TRUJAPAN 1	DISTANCIA	1	
	2	TRUJAPAN 2	42.040		
1	TRUJAPAN 1		12.450	PROMEDIO-AVERAGE	
				56.05 km/h	TIEMPO TIME 01:00

DISTANCIA		DIRECCIÓN DIRECTION	PAV	INFORMACIÓN INFORMATION	DIST. REG. TO GO
TOTAL	PARCIAL				
0.000	0.000	 1 12.450		 CONTROL "A" BARDA DE PIEDRA L.I. 18°10'02.3"N 97°34'24.8"W	42.040
1.120	1.120	 2 11.330		!!	40.920
1.560	0.440	 3 10.890		!!!	40.480
2.310	0.750	 4 10.140		!!!	39.730
2.680	0.370	 5 9.770		!!!	39.360

DISTANCIA A LA PRÓXIMA INSTRUCCIÓN	0.190
------------------------------------	-------

SS TC TC CH	1	TRUJAPAN 1	DISTANCIA	1	
	2	TRUJAPAN 2	42.040		
1	TRUJAPAN 1		12.450	PROMEDIO-AVERAGE	
				56.05 km/h	TIEMPO TIME 01:15

DISTANCIA		DIRECCIÓN DIRECTION	PAV.	INFORMACIÓN INFORMATION	DIST. REG. TO GO
TOTAL	PARCIAL				
2.870	0.190			1 !! 2 !!!	39.170
3.180	0.310			!! Y PUENTE	38.860
3.850	0.670			KM 13	38.190
3.990	0.140			!!	38.050
5.190	1.200			!	36.850

DISTANCIA A LA PRÓXIMA INSTRUCCIÓN	0.260
------------------------------------	-------

SS TC TC CH	1	TRUJAPAN 1	DISTANCIA	1
	2	TRUJAPAN 2	42.040	
1	TRUJAPAN 1	12.450	PROMEDIO-AVERAGE	TIEMPO TIME
			56.05 km/h	01:15

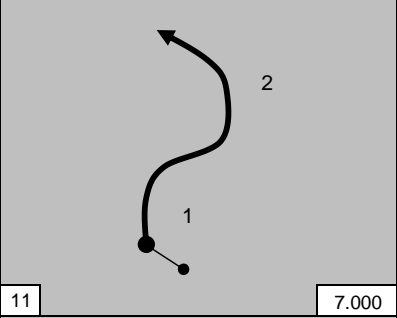
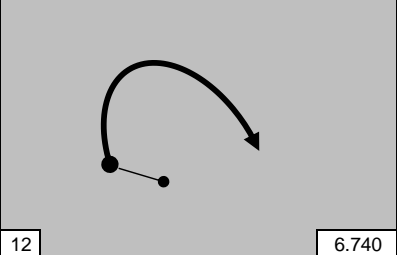
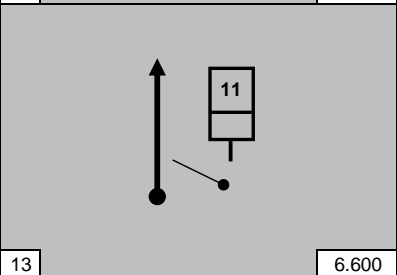
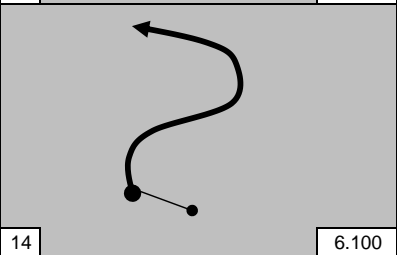
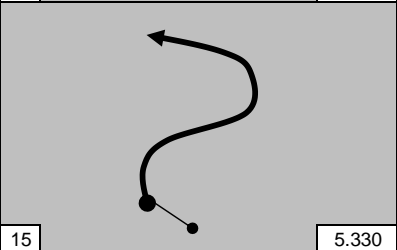
DISTANCIA		DIRECCIÓN DIRECTION	PAV	INFORMACIÓN INFORMATION	DIST. REG. TO GO
TOTAL	PARCIAL				
5.450	0.260			1!! 2!!	36.590
5.710	0.260			!!!	36.330
5.850	0.140			KM 11	36.190
6.350	0.500			!!	35.690
7.120	0.770			!!	34.920



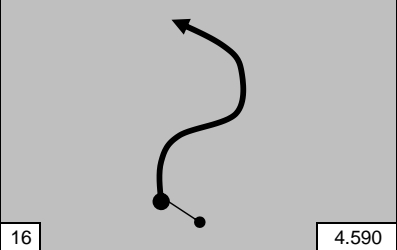
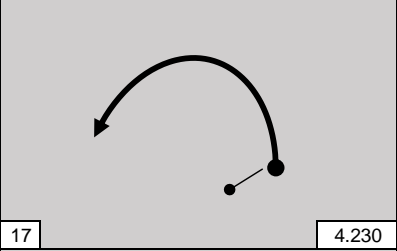
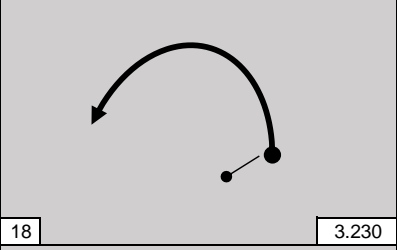
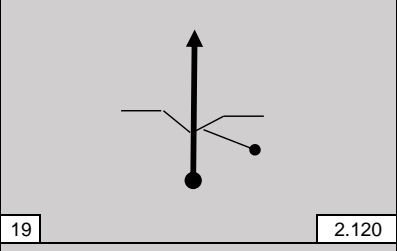
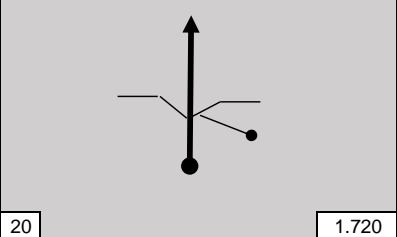

DISTANCIA A LA PRÓXIMA INSTRUCCIÓN	0.740
------------------------------------	-------

TC CH TC CH	1	TRUJAPAN 1	DISTANCIA	1
	2	TRUJAPAN 2	42.040	
1	TRUJAPAN 1	12.450	PROMEDIO-AVERAGE	TIEMPO TIME
			56.05 km/h	01:15

DISTANCIA		DIRECCIÓN DIRECTION	PAV	INFORMACIÓN INFORMATION	DIST. REG. TO GO
TOTAL	PARCIAL				
7.860	0.740	 16 4.590		!!	34.180
8.220	0.360	 17 4.230		!!	33.820
9.220	1.000	 18 3.230		!!	32.820
10.330	1.110	 19 2.120		!!	31.710
10.730	0.400	 20 1.720		!	31.310

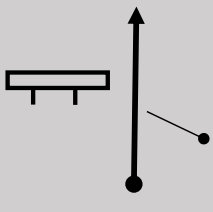
DISTANCIA A LA PRÓXIMA INSTRUCCIÓN	1.720
------------------------------------	-------

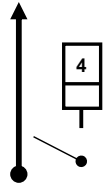
TC CH TC CH	1	TRUJAPAN 1	DISTANCIA	1	
	2	TRUJAPAN 2	42.040		
1	TRUJAPAN 1		12.450	PROMEDIO-AVERAGE	
				56.05 km/h	TIEMPO TIME 01:15

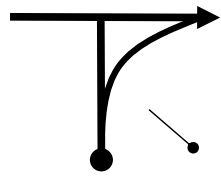
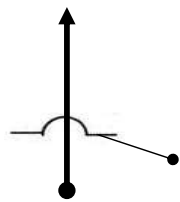
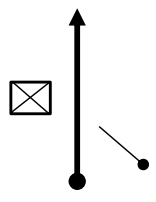
DISTANCIA		DIRECCIÓN DIRECTION	PAV	INFORMACIÓN INFORMATION	DIST. REG. TO GO
TOTAL	PARCIAL				
12.450	1.720	 21 0.000		 CONTROL "B" LET. INVERTIDO SAN JOSE TRUJAPAN N18°12.187' W97°32.949'	29.590
12.890	0.440	 22		 CONTROL "C" KM 4	29.150
16.870	3.980	 23		POR LA DERECHA POR CARRETERA FEDERAL	25.170
17.250	0.380	 24		TOPES (4)	24.790
17.860	0.610	 25		PEMEX L.I. SE PERMITE RECARGA	24.180

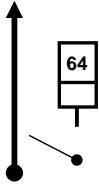
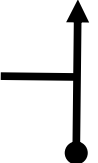
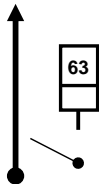
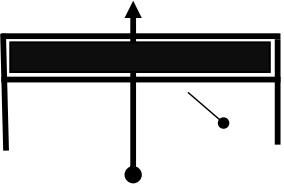
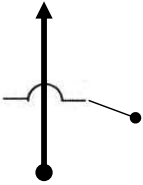

DISTANCIA A LA PRÓXIMA INSTRUCCIÓN	0.190
------------------------------------	-------

TC CH TC CH	1	TRUJAPAN 1	DISTANCIA	1
	2	TRUJAPAN 2	42.040	
1	TRUJAPAN 1	12.450	PROMEDIO-AVERAGE	TIEMPO TIME
			56.05 km/h	01:15

DISTANCIA		DIRECCIÓN DIRECTION	PAV	INFORMACIÓN INFORMATION	DIST. REG. TO GO
TOTAL	PARCIAL				
18.050	0.190	 26		KM 64	23.990
18.550	0.500	 27		DE FRENTE ENTRONQUE OLLERAS DE BUSTAMANTE	23.490
19.050	0.500	 28		KM 63	22.990
24.230	5.180	 29		LETRERO ELEVADO OAXACA	17.810
32.180	7.950	 30		TOPE	9.860



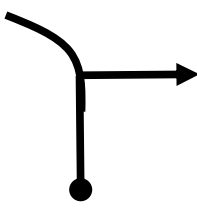
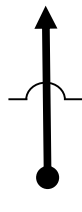
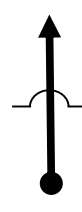

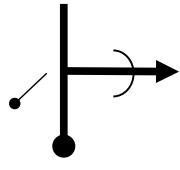
DISTANCIA A LA PRÓXIMA INSTRUCCIÓN	0.140
------------------------------------	-------

TC CH TC CH	1	TRUJAPAN 1	DISTANCIA	1	
	2	TRUJAPAN 2	42.040		
1	TRUJAPAN 1		12.450	PROMEDIO-AVERAGE	
				56.05 km/h	TIEMPO TIME 01:15

DISTANCIA		DIRECCIÓN DIRECTION	PAV	INFORMACIÓN INFORMATION	DIST. REG. TO GO
TOTAL	PARCIAL				
32.320	0.140			ENTRONQUE A LA DERECHA A CALTEPEC	9.720
32.420	0.100			TOPES (3)	9.620
34.740	2.320			TOPES (2)	7.300
36.180	1.440			TOPES (2)	5.860
36.540	0.360			A LA DERECHA A ATZUMBA Y TOPE	5.500

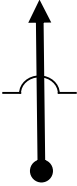
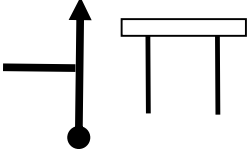

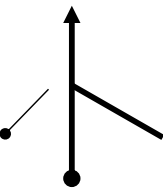

DISTANCIA A LA PRÓXIMA INSTRUCCIÓN	0.050
------------------------------------	-------

TC CH TC CH	1	TRUJAPAN 1	DISTANCIA	1	
	2	TRUJAPAN 2	42.040		
1	TRUJAPAN 1		12.450	PROMEDIO-AVERAGE	
				56.05 km/h	TIEMPO TIME 01:15

DISTANCIA		DIRECCIÓN DIRECTION	PAV.	INFORMACIÓN INFORMATION	DIST. REG. TO GO
TOTAL	PARCIAL				
36.590	0.050			TOPE (2)	5.450
		36			
41.030	4.440			LETRERO SAN PABLO DE FRENTE	1.010
		37			
41.990	0.960			 CONTROL "CH" MARCA EN PISO L.D.	0.050
		38			
42.040	0.050			 CONTROL "A" MARCA EN PISO BARDA DE PIEDRA L.I. 18°10'02.3"N 97°34'24.8"W	0.000
		39			
		25			

DISTANCIA A LA PRÓXIMA INSTRUCCIÓN	0.000
------------------------------------	-------

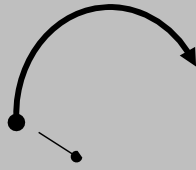
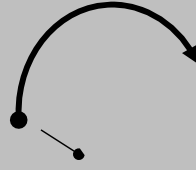
SS TC TC CH	2	TRUJAPAN 2	DISTANCIA	2	
	3	OLLERAS 1	25.900		
2	TRUJAPAN 2		12.450	PROMEDIO-AVERAGE	
				47.09 km/h	TIEMPO TIME 00:33

DISTANCIA		DIRECCIÓN DIRECTION	PAV	INFORMACIÓN INFORMATION	DIST. REG. TO GO
TOTAL	PARCIAL				
0.000	0.000	 1 12.450		 CONTROL "A" BARDA DE PIEDRA L.I. 18°10'02.3"N 97°34'24.8"W	25.900
1.120	1.120	 2 11.330		!!	24.780
1.560	0.440	 3 10.890		!!!	24.340
2.310	0.750	 4 10.140		!!!	23.590
2.680	0.370	 5 9.770		!!!	23.220

DISTANCIA A LA PRÓXIMA INSTRUCCIÓN	0.190
------------------------------------	-------

SS TC TC CH	2	TRUJAPAN 2	DISTANCIA	2
	3	OLLERAS 1	25.900	
2	TRUJAPAN 2	12.450	PROMEDIO-AVERAGE	TIEMPO TIME
			47.09 km/h	00:33

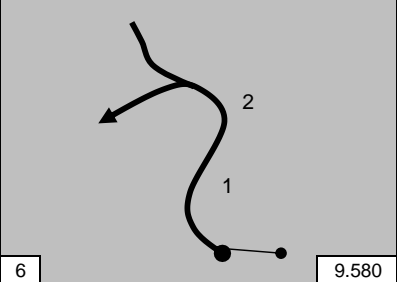
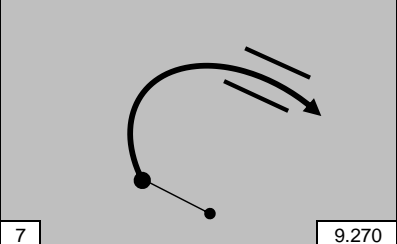
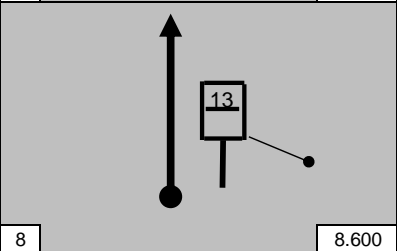
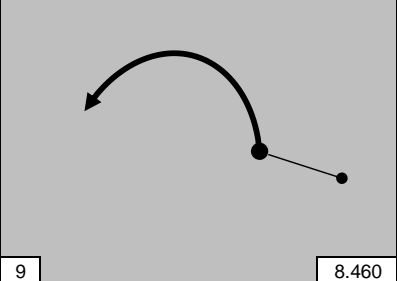
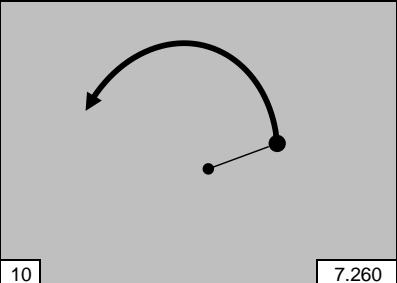
DISTANCIA		DIRECCIÓN DIRECTION	PAV.	INFORMACIÓN INFORMATION	DIST. REG. TO GO
TOTAL	PARCIAL				
2.870	0.190			1 !! 2 !!!	23.030
3.180	0.310			!! Y PUENTE	22.720
3.850	0.670			KM 13	22.050
3.990	0.140			!!	21.910
5.190	1.200			!	20.710

DISTANCIA A LA PRÓXIMA INSTRUCCIÓN	0.260
------------------------------------	-------

SS TC TC CH	2	TRUJAPAN 2	DISTANCIA	2
	3	OLLERAS 1	25.900	
2	TRUJAPAN 2	12.450	PROMEDIO-AVERAGE	TIEMPO TIME
			47.09 km/h	00:33

DISTANCIA		DIRECCIÓN DIRECTION	PAV	INFORMACIÓN INFORMATION	DIST. REG. TO GO
TOTAL	PARCIAL				
5.450	0.260	 11 7.000		1!! 2!!	20.450
5.710	0.260	 12 6.740		!!!	20.190
5.850	0.140	 13 6.600		KM 11	20.050
6.350	0.500	 14 6.100		!!	19.550
7.120	0.770	 15 5.330		!!	18.780



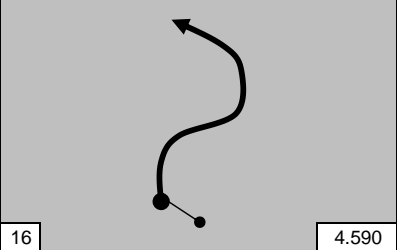
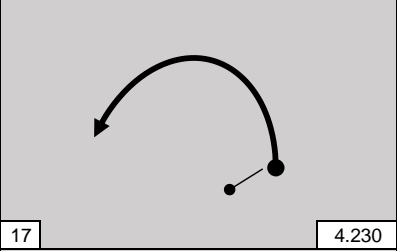
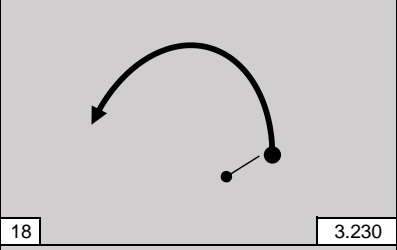
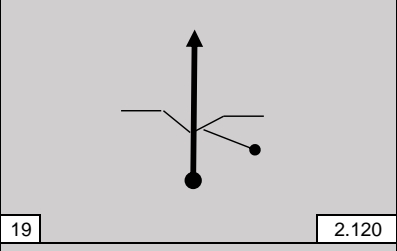
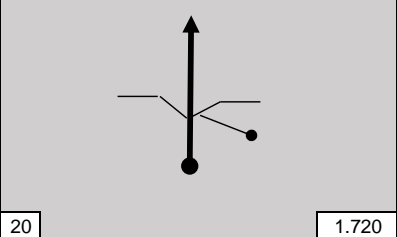

DISTANCIA A LA PRÓXIMA INSTRUCCIÓN	0.740
------------------------------------	-------

TC CH TC CH	2	TRUJAPAN 2	DISTANCIA	2
	3	OLLERAS 1	25.900	
2	TRUJAPAN 2	12.450	PROMEDIO-AVERAGE	TIEMPO TIME
			47.09 km/h	00:33

DISTANCIA		DIRECCIÓN DIRECTION	PAV	INFORMACIÓN INFORMATION	DIST. REG. TO GO
TOTAL	PARCIAL				
7.860	0.740	 16 4.590		!!	18.040
8.220	0.360	 17 4.230		!!	17.680
9.220	1.000	 18 3.230		!!	16.680
10.330	1.110	 19 2.120		!!	15.570
10.730	0.400	 20 1.720		!	15.170

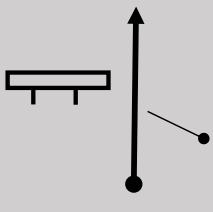

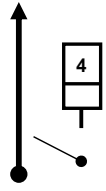
DISTANCIA A LA PRÓXIMA INSTRUCCIÓN	1.720
------------------------------------	-------

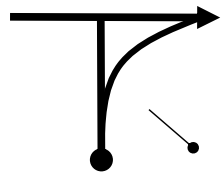
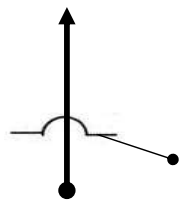
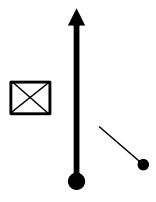
TC CH TC CH	2	TRUJAPAN 2	DISTANCIA	2	
	3	OLLERAS 1	25.900		
2	TRUJAPAN 2		12.450	PROMEDIO-AVERAGE	
				47.09 km/h	TIEMPO TIME 00:33

DISTANCIA		DIRECCIÓN DIRECTION	PAV	INFORMACIÓN INFORMATION	DIST. REG. TO GO
TOTAL	PARCIAL				
12.450	1.720	 21 0.000		 CONTROL "B" LET. INVERTIDO SAN JOSE TRUJAPAN N18°12.187' W97°32.949'	13.450
12.890	0.440	 22		 CONTROL "C" KM 4	13.010
16.870	3.980	 23		POR LA DERECHA POR CARRETERA FEDERAL	9.030
17.250	0.380	 24		TOPES (4)	8.650
17.860	0.610	 25		PEMEX L.I. SE PERMITE RECARGA	8.040

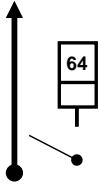
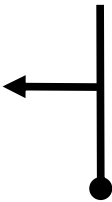
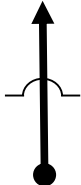
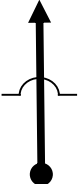

DISTANCIA A LA PRÓXIMA INSTRUCCIÓN	0.190
------------------------------------	-------

TC CH	2	TRUJAPAN 2	DISTANCIA	2
	3	OLLERAS 1	25.900	
2	TRUJAPAN 2	12.450	PROMEDIO-AVERAGE	TIEMPO TIME
			47.09 km/h	00:33

DISTANCIA		DIRECCIÓN DIRECTION	PAV	INFORMACIÓN INFORMATION	DIST. REG. TO GO
TOTAL	PARCIAL				
18.050	0.190			KM 64	7.850
		21			
18.550	0.500			POR LA IZQUIERDA A OLLERAS DE BUSTAMANTE PRECAUCION	7.350
		22			
20.930	2.380			TOPE (3)	4.970
		23			
25.130	4.200			TOPE (4) POBLACION OLLERAS DE BUSTAMANTE	0.770
		24			
25.850	0.720			 CONTROL "CH" MARCA EN PISO L.D.	0.050
		25			

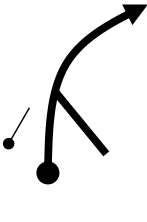

DISTANCIA A LA PRÓXIMA INSTRUCCIÓN	0.050
------------------------------------	-------

TC CH TC CH	2	TRUJAPAN 2	DISTANCIA	2
	3	OLLERAS 1	25.900	
2	TRUJAPAN 2	12.450	PROMEDIO-AVERAGE	TIEMPO TIME
			47.09 km/h	00:33

DISTANCIA		DIRECCIÓN DIRECTION	PAV	INFORMACIÓN INFORMATION	DIST. REG. TO GO
TOTAL	PARCIAL				
25.900	0.050			 CONTROL "A" MARCA EN PISO L.D. 18°13.343'N 097°42.797'W	0.000

DISTANCIA A LA PRÓXIMA INSTRUCCIÓN	#¡REF!
------------------------------------	--------

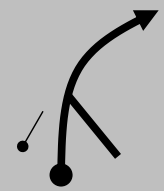
SS TC TC CH	3	SANTO DOMINGO 1	DISTANCIA		3
	3A	SERVICIO A	16.500		
3	SANTO DOMINGO 1		14.700	PROMEDIO-AVERAGE	
				49.5 Km/h	TIEMPO TIME
				00:20	

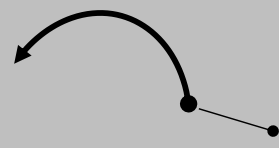
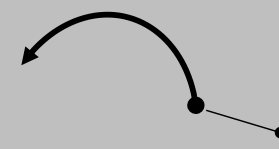
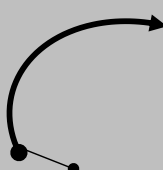
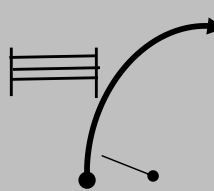
DISTANCIA		DIRECCIÓN DIRECTION	PAV	INFORMACIÓN INFORMATION	DIST. REG. TO GO
TOTAL	PARCIAL				
0.000	0.000			 CONTROL "A" MARCA EN PISO L.D. 18°13.343'N 097°42.797'W	16.500
		1 14.700			
0.540	0.540			!!	15.960
		2 14.160			
0.890	0.350			!!	15.610
		3 13.810			
2.700	1.810			!	13.800
		4 12.000			
3.550	0.850			EN LOMO CON GUARDA GANADO	12.950
		5 11.150			





DISTANCIA A LA PRÓXIMA INSTRUCCIÓN	0.770
------------------------------------	-------

SS TC TC CH	3	SANTO DOMINGO 1	DISTANCIA	3		
	3A	SERVICIO A	16.500			
3	SANTO DOMINGO 1		14.700	PROMEDIO-AVERAGE	TIEMPO TIME	00:20
				49.5 Km/h		

DISTANCIA		DIRECCIÓN DIRECTION	P.V.	INFORMACIÓN INFORMATION	DIST. REG. TO GO
TOTAL	PARCIAL				
4.320	0.770			!!	12.180
5.530	1.210			!! y PUENTE	10.970
6.500	0.970			EN LOMO CON GUARDA GANADO	10.000
8.710	2.210			1 ! 2 !! 3 !!	7.790
10.900	2.190			GUARDA GANADO	5.600

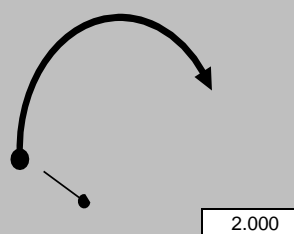
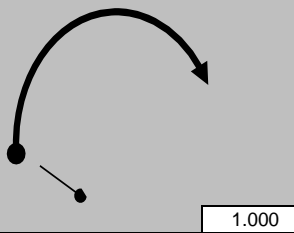
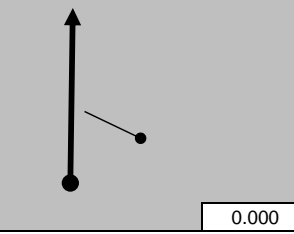

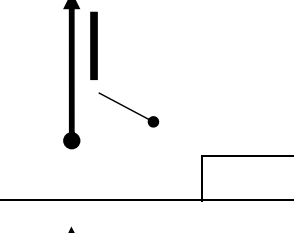
DISTANCIA A LA PRÓXIMA INSTRUCCIÓN	1.800
------------------------------------	-------

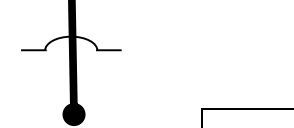
SS TC TC CH	3	SANTO DOMINGO 1	DISTANCIA		3
	3A	SERVICIO A	16.500		
3	SANTO DOMINGO 1		14.700	PROMEDIO-AVERAGE	TIEMPO TIME
				49.5 Km/h	

DISTANCIA		DIRECCIÓN DIRECTION	PAV	INFORMACIÓN INFORMATION	DIST. REG. TO GO
TOTAL	PARCIAL				
12.700	1.800	 11 2.000		!!! LARGA	3.800
13.700	1.000	 12 1.000		!!	2.800
14.700	1.000	 13 0.000		 CONTROL "B" FRENTE A REJA ROJA L.I. 18°16'17.3"N 97°47'37.9"W	1.800
15.200	0.500	 14		 CONTROL "C" MARCA EN INICIO DE BANQUETA L.D.	1.300
15.300	0.100	 15		TOPE (4)	1.200

DISTANCIA A LA PRÓXIMA INSTRUCCIÓN	0.600
------------------------------------	-------

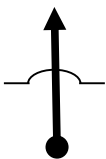
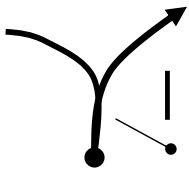
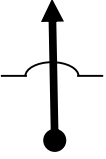
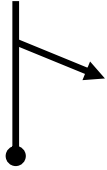
SS TC TC CH	3	SANTO DOMINGO 1	DISTANCIA	3		
	3A	SERVICIO A	16.500			
3	SANTO DOMINGO 1		14.700	PROMEDIO-AVERAGE	TIEMPO TIME	00:20
				49.5 Km/h		

DISTANCIA		DIRECCIÓN DIRECTION	PAV	INFORMACIÓN INFORMATION	DIST. REG. TO GO
TOTAL	PARCIAL				
15.900	0.600			TOPE (4)	0.600
		16			
16.290	0.390			POR LA DERECHA FRENTE A IGLESIA COMIENZA CALLE DE CEMENTO	0.210
		17			
16.320	0.030			TOPE	0.180
		18			
16.390	0.070			POR LA DERECHA FRENTE A TIENDA EL RUBI	0.110
		19			
16.500	0.110			 CONTROL "CH" Entrada a SERVICIO	0.000
		20			

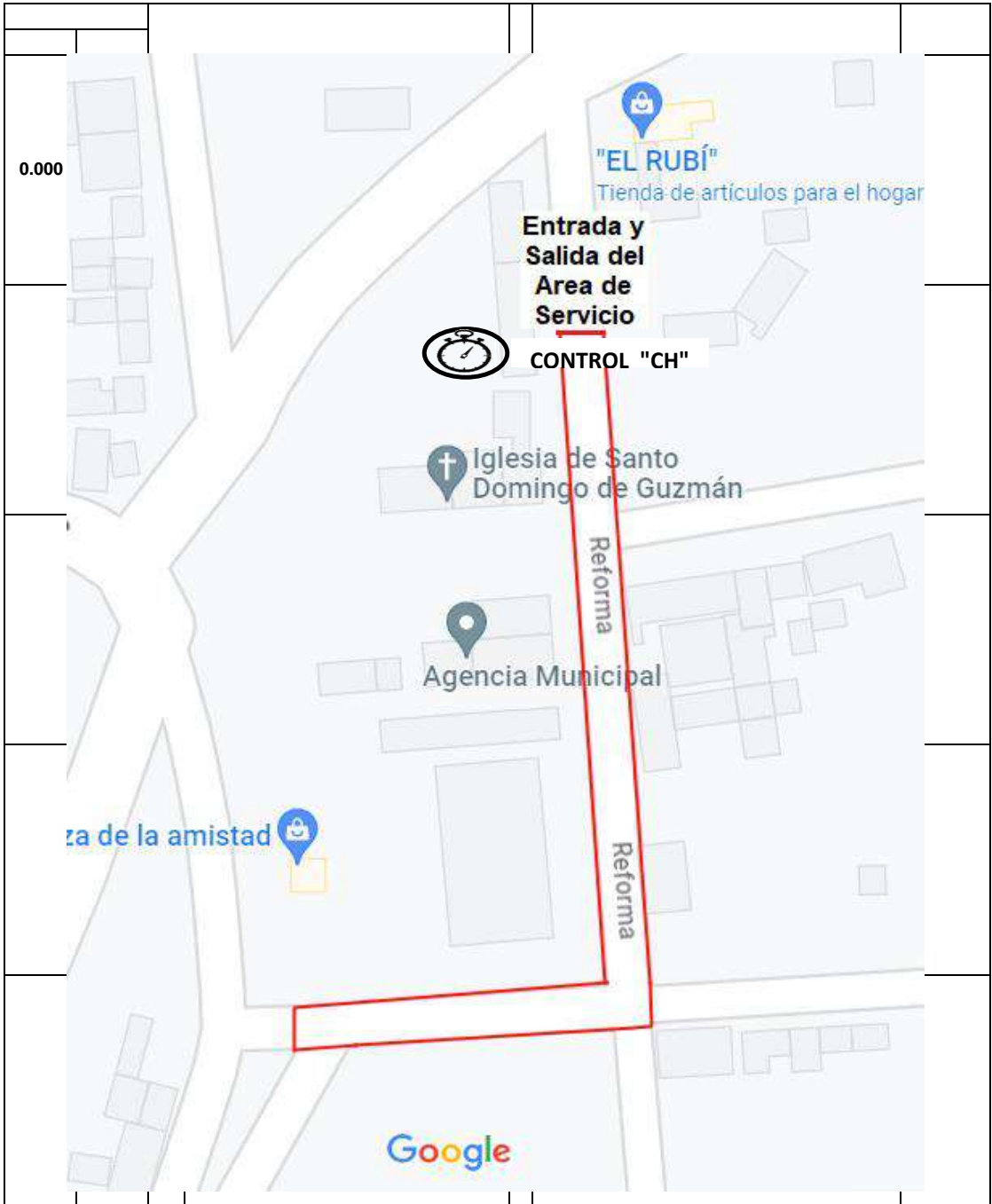

DISTANCIA A LA PRÓXIMA INSTRUCCIÓN	0.000
------------------------------------	-------

3A	SERVICIO A	0.000 Km.	3A
	SANTO DOMINGO		
			TIEMPO TIME 00:45



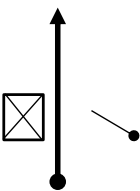
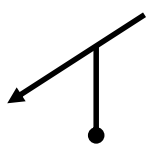
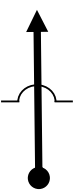

DISTANCIA A LA PRÓXIMA INSTRUCCIÓN	0.000
------------------------------------	-------

SS TC TC CH	3A	SERVICIO A	DISTANCIA	3B
	3B	RECLASIFICACIÓN	0.180	
			PROMEDIO-AVERAGE	TIEMPO TIME
			0.180	00:00
			46 KM/H	

DISTANCIA		DIRECCIÓN DIRECTION	PAV	INFORMACIÓN INFORMATION	DIST. REG. TO GO
TOTAL	PARCIAL				
0.000	0.000			DE FRENTE	0.180
		1			
0.110	0.110			POR LA IZQUIERDA	0.070
		2			
0.180	0.070			 CONTROL "CH" TOPE ENTRADA A RECLASIFICACION	0.000
		3			
		4			
		5			

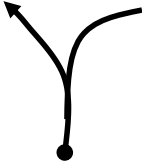
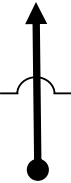
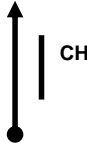

DISTANCIA A LA PRÓXIMA INSTRUCCIÓN 1.920

SS TC TC CH	3C	SALIDA RECLASIFICACION	DISTANCIA	3C
	4	OLLERAS 1	2.020	
			PROMEDIO-AVERAGE	TIEMPO TIME 00:03
			2.020 46 KM/H	

DISTANCIA		DIRECCIÓN DIRECTION	PAV	INFORMACIÓN INFORMATION	DIST. REG. TO GO
TOTAL	PARCIAL				
0.000	0.000			SALIDA DE RECLASIFICACION POR LA IZQUIERDA	2.200
		1			
0.100	0.100			TOPE (8)	2.100
		2			
2.020	1.920			 CONTROL "CH" MARCA EN PISO L.D.	0.180
		3			
		4			
		5			

DISTANCIA A LA PRÓXIMA INSTRUCCIÓN 1.920

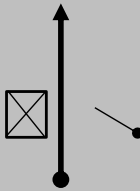
SS TC TC CH	4	OLLERAS 1	DISTANCIA		4
	5	ATZUMBA 1	28.06 KM		
4	OLLERAS 1		15.500	PROMEDIO-AVERAGE	TIEMPO TIME 00:36
				51.92 KM/H	

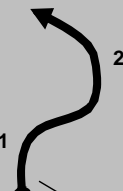
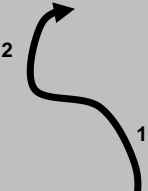
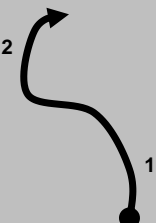
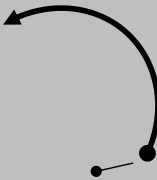
DISTANCIA		DIRECCIÓN DIRECCION	PAV	INFORMACIÓN INFORMATION	DIST. REG. TO GO
TOTAL	PARCIAL				
0.000	0.000			 CONTROL "A" MARCA EN PISO LADO DERECHO 18°16.443'N 97°47.711'W	28.060
0.870	0.870			1 ! 2 !!	27.190
1.100	0.230			1 !! LARGA 2 !	26.960
1.840	0.740			1 ! 2 !	26.220
2.200	0.360			!! LARGA	25.860

DISTANCIA A LA PRÓXIMA INSTRUCCIÓN	0.640
------------------------------------	-------

SS TC TC CH	4	OLLERAS 1	DISTANCIA	4
	5	ATZUMBA 1	28.06 KM	
4	OLLERAS 1	15.500	PROMEDIO-AVERAGE	TIEMPO TIME
			51.92 KM/H	00:36

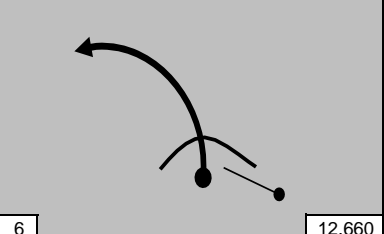
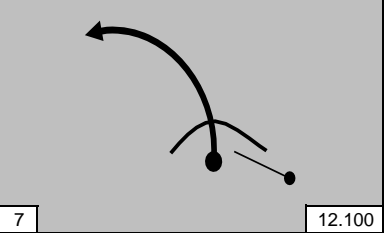
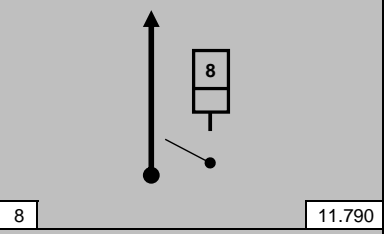
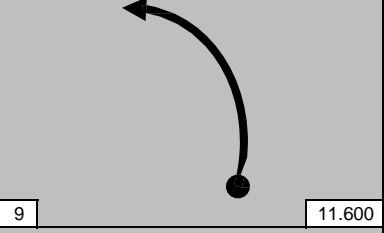
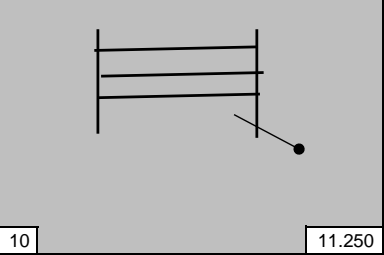
DISTANCIA		DIRECCIÓN DIRECTION	PAV	INFORMACIÓN INFORMATION	DIST. REG. TO GO
TOTAL	PARCIAL				
2.840	0.640			LOMO IZQUIERDA !	25.220
		6 12.660			
3.400	0.560			LOMO IZQUIERDA LARGA	24.660
		7 12.100			
3.710	0.310			KM 18	24.350
		8 11.790			
3.900	0.190			!! LARGA	24.160
		9 11.600			
4.250	0.350			GUARDA GANADO	23.810
		10 11.250			
DISTANCIA A LA PRÓXIMA INSTRUCCIÓN		1.050			

SS TC TC CH	4	OLLERAS 1	DISTANCIA	4
	5	ATZUMBA 1	28.06 KM	
4	OLLERAS 1	15.500	PROMEDIO-AVERAGE	TIEMPO TIME
			51.92 KM/H	00:36

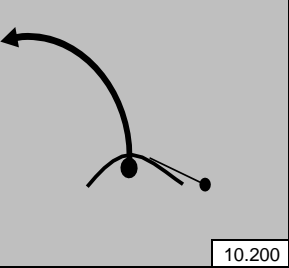
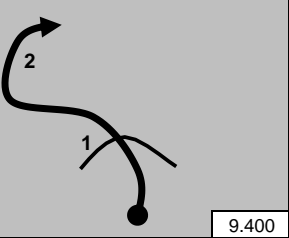
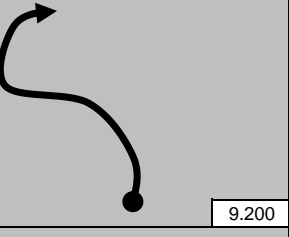
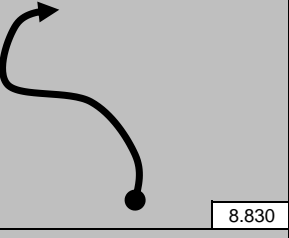
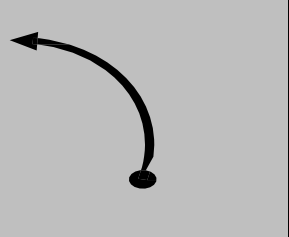
DISTANCIA		DIRECCIÓN DIRECTION	P.V.	INFORMACIÓN INFORMATION	DIST. REG. TO GO
TOTAL	PARCIAL				
5.300	1.050			LOMO IZQ !	22.760
		11 10.200			
6.100	0.800			LOMO 1 ! 2 !!	21.960
		12 9.400			
6.300	0.200			1 ! 2 !!	21.760
		13 9.200			
6.670	0.370			1 ! 2 !!	21.390
		14 8.830			
6.850	0.180			!!	21.210
		15 8.650			

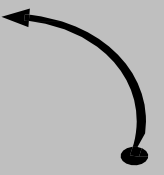
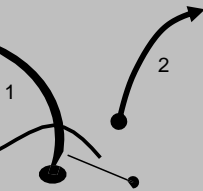
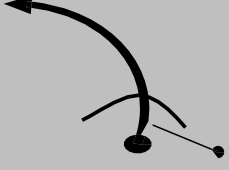
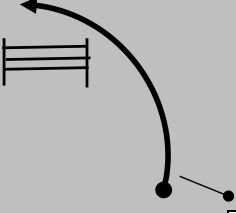
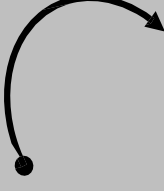

DISTANCIA A LA PRÓXIMA INSTRUCCIÓN	0.850
------------------------------------	-------

SS TC TC CH	4	OLLERAS 1	DISTANCIA	4
	5	ATZUMBA 1	28.06 KM	
4	OLLERAS 1	15.500	PROMEDIO-AVERAGE	TIEMPO TIME 00:36
			51.92 KM/H	

DISTANCIA		DIRECCIÓN DIRECTION	P.V.	INFORMACIÓN INFORMATION	DIST. REG. TO GO
TOTAL	PARCIAL				
7.700	0.850			!	20.360
		16 7.800			
7.960	0.260			LOMO IZQUIERDA, DERECHA	20.100
		17 7.540			
8.200	0.240			IZQUIERDA EN LOMO	19.860
		18 7.300			
8.600	0.400			GUARDA GANADO EN LOMO IZQUIERDA	19.460
		19 6.900			
9.270	0.670			!!	18.790
		20 6.230			



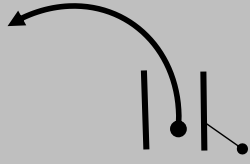

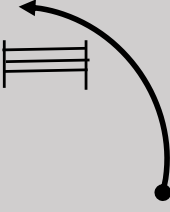
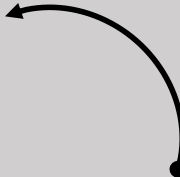
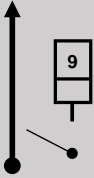
DISTANCIA A LA PRÓXIMA INSTRUCCIÓN	0.230
------------------------------------	-------

SS TC TC CH	4	OLLERAS 1	DISTANCIA		4
	5	ATZUMBA 1	28.060 KM		
4	OLLERAS 1		15.500	PROMEDIO-AVERAGE	TIEMPO TIME 00:36
				51.92 KM/H	

DISTANCIA		DIRECCIÓN	PAV	INFORMACIÓN	DIST. REG. TO GO
TOTAL	PARCIAL	DIRECCION		INFORMATION	
9.500	0.230	 21 6.000		PUENTE IZQ !!	18.560
10.800	1.300	 22 4.700		!!	17.260
11.600	0.800	 23 3.900		IZQ EN LOMO CON GUARDA GANADO	16.460
11.800	0.200	 24 3.700		!!	16.260
12.900	1.100	 25 2.600		KM 9	15.160

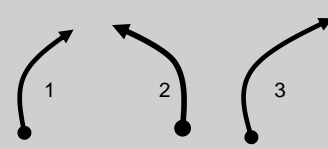
DISTANCIA A LA PRÓXIMA INSTRUCCIÓN	1.300
------------------------------------	-------

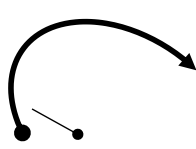
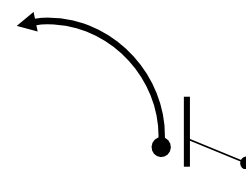
SS TC TC CH	4	OLLERAS 1	DISTANCIA		4
	5	ATZUMBA 1	28.060		
4	OLLERAS 1		15.500	PROMEDIO-AVERAGE	TIEMPO TIME
				51.92 KM/H	

DISTANCIA		DIRECCIÓN DIRECCION	PAV	INFORMACIÓN INFORMATION	DIST. REG. TO GO
TOTAL	PARCIAL				
14.200	1.300			!!!	13.860
		26 1.300			
15.100	0.900			1 ! 2 !! 3!!	12.960
		27 0.400			
15.500	0.400			 CONTROL "B" CONTROL B LOMO IZQ 18°13.265'N 97°42.717'W	12.560
		28 0.000			
15.600	0.100			!!!	12.460
		29			
15.900	0.300			 CONTROL "C" CAMINO DE CEMENTO L.D. MARCA EN PISO L.D.	12.160
		30			



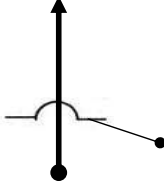
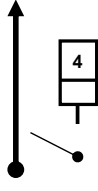
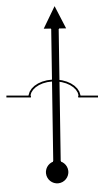
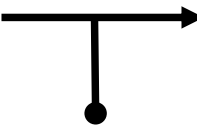
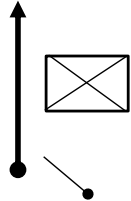

DISTANCIA A LA PRÓXIMA INSTRUCCIÓN	0.200
------------------------------------	-------

SS TC TC CH	4	OLLERAS 1	DISTANCIA		4
	5	ATZUMBA 1	28.060 KM		
4	OLLERAS 1		15.500	PROMEDIO-AVERAGE	TIEMPO TIME 00:36
				51.92 KM/H	

DISTANCIA		DIRECCIÓN DIRECCION	PAV	INFORMACIÓN INFORMATION	DIST. REG. TO GO
TOTAL	PARCIAL				
16.100	0.200			TOPES (4) POBLACIÓN OLLERAS	11.960
17.800	1.700			KM 4	10.260
20.400	2.600			TOPES (3)	7.660
21.800	1.400			POR LA DERECHA A CHAZUMBA	6.260
22.500	0.700			PEMEX LADO DERECHO SE PERMITE RECARGAR	5.560

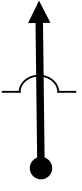
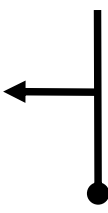
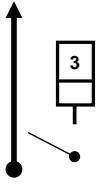
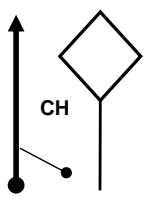

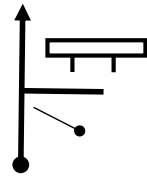

DISTANCIA A LA PRÓXIMA INSTRUCCIÓN 0.000

TC CH TC CH	4	OLLERAS 1	DISTANCIA	4
	5	ATZUMBA 1	28.060	
4	OLLERAS 1	15.500	PROMEDIO-AVERAGE	TIEMPO TIME 00:36
			51.92 KM/H	

DISTANCIA		DIRECCIÓN DIRECTION	PAV	INFORMACIÓN INFORMATION	DIST. REG. TO GO
TOTAL	PARCIAL				
22.680	0.180			TOPES (3)	5.380
		1			
23.620	0.940			POR LA IZQUIERDA A SAN JOSE TRUJAPAN PRECAUCION	4.440
		2			
26.600	2.980			KM 3	1.460
		3			
27.890	1.290			 CONTROL "CH" SEÑAL L.D.	0.170
28.060	0.170			 CONTROL "A" LET. SAN JOSE TRUJAPAN	0.000

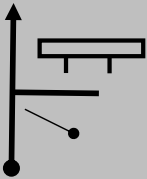
DISTANCIA A LA PRÓXIMA INSTRUCCIÓN	0.150
------------------------------------	-------

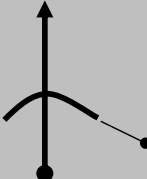
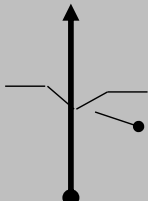
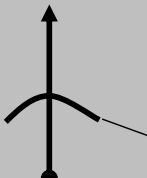
SS TC TC CH	5	ATZUMBA	DISTANCIA	5
	6	ATZUMBA 2	42.100	
5	ATZUMBA		12.450	PROMEDIO-AVERAGE
				56.13 KM/H
				TIEMPO TIME 01:00



DISTANCIA		DIRECCIÓN DIRECTION	PAV	INFORMACIÓN INFORMATION	DIST. REG. TO GO
TOTAL	PARCIAL				
0.000	0.000			 CONTROL "A" LET. SAN JOSE TRUJAPAN 18° 10.216' N 97° 38.700' W	42.100
		1 17.280			
1.540	1.540			LOMO	40.560
		2 15.740			
2.100	0.560			!!	40.000
		3 15.180			
2.900	0.800			LOMO	39.200
		4 14.380			
3.180	0.280			!!	38.920
		5 14.100			

DISTANCIA A LA PRÓXIMA INSTRUCCIÓN	1.010
------------------------------------	-------

SS TC TC CH	5	ATZUMBA	DISTANCIA	5
	6	ATZUMBA 2	42.100	
5	ATZUMBA	12.450	PROMEDIO-AVERAGE	TIEMPO TIME
			56.13 KM/H	01:00



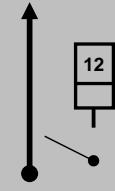

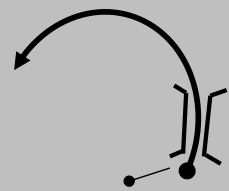
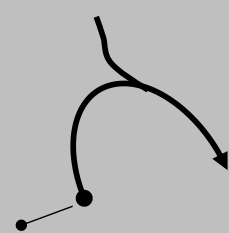
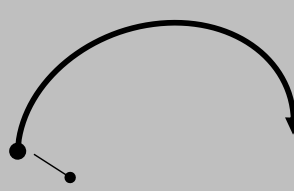
DISTANCIA		DIRECCIÓN DIRECTION	PAV	INFORMACIÓN INFORMATION	DIST. REG. TO GO
TOTAL	PARCIAL				
4.190	1.010			!	37.910
		6 13.090			
5.180	0.990			!!	36.920
		7 12.100			
6.010	0.830			!!	36.090
		8 11.270			
6.700	0.690			!!!	35.400
		9 10.580			
7.220	0.520			!!	34.880
		10 10.060			
DISTANCIA A LA PRÓXIMA INSTRUCCIÓN		0.370			

SS TC TC CH	5	ATZUMBA	DISTANCIA	5
	6	ATZUMBA 2	42.100	
5	ATZUMBA	12.450	PROMEDIO-AVERAGE	TIEMPO TIME
			56.13 KM/H	01:00

DISTANCIA		DIRECCIÓN DIRECTION	P.V.	INFORMACIÓN INFORMATION	DIST. REG. TO GO
TOTAL	PARCIAL				
7.590	0.370			KM 12	34.510
		11 9.690			
8.400	0.810			!!	33.700
		12 8.880			
9.170	0.770			PUENTE Y !!	32.930
		13 8.110			
9.350	0.180			!!!	32.750
		14 7.930			
10.400	1.050			! LARGA	31.700
		15 6.880			

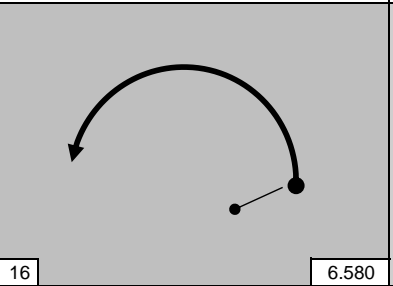
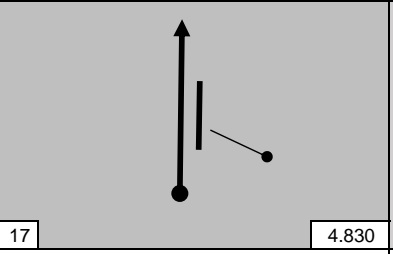
DISTANCIA A LA PRÓXIMA INSTRUCCIÓN	0.300
------------------------------------	-------

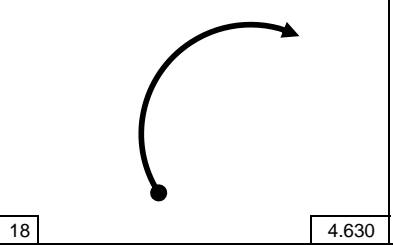
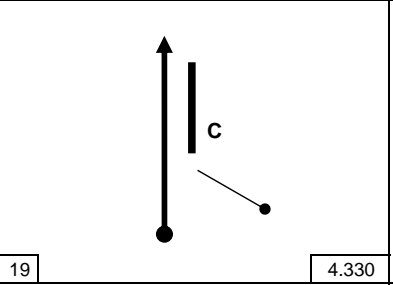
SS TC TC CH	5	ATZUMBA	DISTANCIA	5
	6	ATZUMBA 2	42.100	
5	ATZUMBA		12.450	PROMEDIO-AVERAGE
				56.13 KM/H
				TIEMPO TIME
				01:00

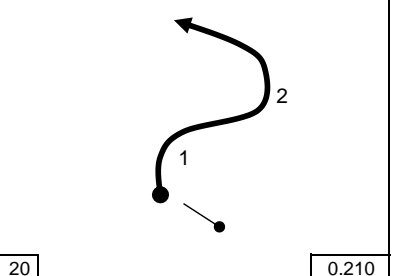
DISTANCIA		DIRECCIÓN DIRECTION	PAV	INFORMACIÓN INFORMATION	DIST. REG. TO GO
TOTAL	PARCIAL				
10.700	0.300			LARGA	31.400
12.450	1.750			 CONTROL "B" BARDA DE PIEDRA L.D. 18°10'02.3"N 97°34'24.8"W	29.650
12.650	0.200			!	29.450
12.950	0.300			 CONTROL "C" MARCA EN PISO CAMINO L.D.	29.150
17.070	4.120			1 ! 2 !!	25.030

DISTANCIA A LA PRÓXIMA INSTRUCCIÓN	0.510
------------------------------------	-------

SS TC TC CH	5	ATZUMBA	DISTANCIA	5
	6	ATZUMBA 2	42.100	
5	ATZUMBA	12.450	PROMEDIO-AVERAGE	TIEMPO TIME
			56.13 KM/H	01:00

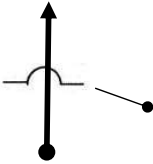
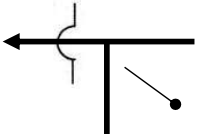
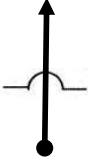
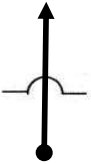
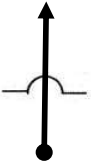
DISTANCIA		DIRECCIÓN DIRECTION	PAV	INFORMACIÓN INFORMATION	DIST. REG. TO GO
TOTAL	PARCIAL				
17.580	0.510			TOPES (2)	24.520
		22			
17.840	0.260			A LA IZQUIERDA Y TOPE	24.260
		23			
17.960	0.120			TOPES (2)	24.140
		24			
19.250	1.290			TOPE	22.850
		25			
19.770	0.520			TOPE	22.330
		26			



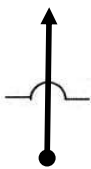
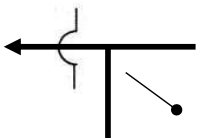
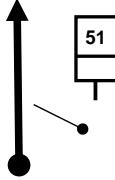
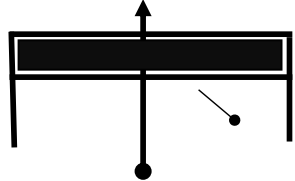
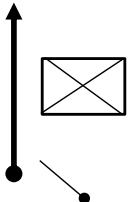

DISTANCIA A LA PRÓXIMA INSTRUCCIÓN	2.120
------------------------------------	-------

SS TC TC CH	5	ATZUMBA	DISTANCIA	5
	6	ATZUMBA 2	42.100	
5	ATZUMBA	12.450	PROMEDIO-AVERAGE	TIEMPO TIME 01:00
			56.13 KM/H	

DISTANCIA		DIRECCIÓN DIRECTION	PAV	INFORMACIÓN INFORMATION	DIST. REG. TO GO
TOTAL	PARCIAL				
21.890	2.120			TOPES (3)	20.210
		16			
22.120	0.230			A LA IZQUIERDA POR CARRETERA FEDERAL Y TOPE.	19.980
		17			
25.220	3.100			KM 51	16.880
		18			
30.070	4.850			LETRERO ELEVADO "OAXACA"	12.030
		19	-4.850		
36.540	6.470			PEMEX LADO DERECHO SE PERMITE RECARGAR	5.560
		20	-11.320		

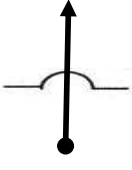
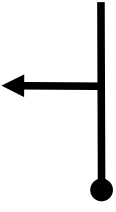
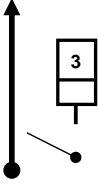
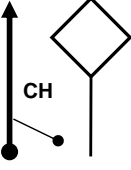

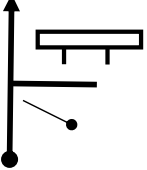

DISTANCIA A LA PRÓXIMA INSTRUCCIÓN	0.180
------------------------------------	-------

SS TC TC CH	5	ATZUMBA	DISTANCIA		5
	6	ATZUMBA 2	42.100		
5	ATZUMBA		12.450	PROMEDIO-AVERAGE	TIEMPO TIME 01:00
				56.13 KM/H	

DISTANCIA		DIRECCIÓN DIRECTION	PAV	INFORMACIÓN INFORMATION	DIST. REG. TO GO
TOTAL	PARCIAL				
36.720	0.180			TOPES (4)	5.380
		16			
37.660	0.940			POR LA IZQUIERDA A SAN JOSE TRUJAPAN PRECAUCION	4.440
		17			
40.640	2.980			KM 3	1.460
		18			
41.930	1.290			 CONTROL "CH" SEÑAL L.D.	0.170
		19	-1.290		
42.100	0.170			 CONTROL "A" LET. SAN JOSE TRUJAPAN	0.000
		20	-1.460		

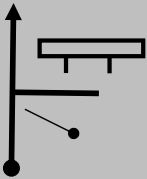
DISTANCIA A LA PRÓXIMA INSTRUCCIÓN	0.000
------------------------------------	-------

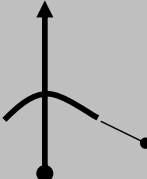
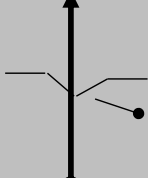
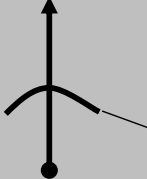
SS TC TC CH	6	ATZUMBA 2	DISTANCIA	6	
	7	SANTO DOMINGO 2	42.840		
6	ATZUMBA 2		14.700	PROMEDIO-AVERAGE	
				57.12 KM/H	TIEMPO TIME 00:45



DISTANCIA		DIRECCIÓN DIRECTION	PAV	INFORMACIÓN INFORMATION	DIST. REG. TO GO
TOTAL	PARCIAL				
0.000	0.000			 CONTROL "A" LET. SAN JOSE TRUJAPAN 18° 10.216' N 97° 38.700' W	42.840
		1 17.280			
1.540	1.540			LOMO	41.300
		2 15.740			
2.100	0.560			!!	40.740
		3 15.180			
2.900	0.800			LOMO	39.940
		4 14.380			
3.180	0.280			!!	39.660
		5 14.100			

DISTANCIA A LA PRÓXIMA INSTRUCCIÓN	1.010
------------------------------------	-------

SS TC TC CH	6	ATZUMBA 2	DISTANCIA	6
	7	SANTO DOMINGO 2	42.840	
6	ATZUMBA 2	14.700	PROMEDIO-AVERAGE	TIEMPO TIME
			57.12 KM/H	00:45

DISTANCIA		DIRECCIÓN DIRECTION	PAV	INFORMACIÓN INFORMATION	DIST. REG. TO GO
TOTAL	PARCIAL				
4.190	1.010			!	38.650
		6 13.090			
5.180	0.990			!!	37.660
		7 12.100			
6.010	0.830			!!	36.830
		8 11.270			
6.700	0.690			!!!	36.140
		9 10.580			
7.220	0.520			!!	35.620
		10 10.060			
DISTANCIA A LA PRÓXIMA INSTRUCCIÓN		0.370			

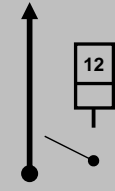
SS TC TC CH	6	ATZUMBA 2	DISTANCIA	6
	7	SANTO DOMINGO 2	42.840	
6	ATZUMBA 2	14.700	PROMEDIO-AVERAGE	TIEMPO TIME
			57.12 KM/H	00:45

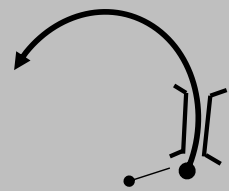
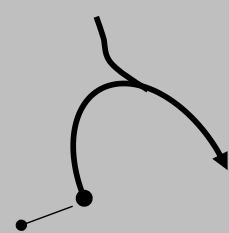
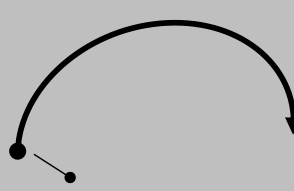
DISTANCIA		DIRECCIÓN DIRECTION	P.V.	INFORMACIÓN INFORMATION	DIST. REG. TO GO
TOTAL	PARCIAL				
7.590	0.370			KM 12	35.250
		11 9.690			
8.400	0.810			!!	34.440
		12 8.880			
9.170	0.770			PUENTE Y !!	33.670
		13 8.110			
9.350	0.180			!!!	33.490
		14 7.930			
10.400	1.050			! LARGA	32.440
		15 6.880			

DISTANCIA A LA PRÓXIMA INSTRUCCIÓN	0.300
------------------------------------	-------

SS TC TC CH	6	ATZUMBA 2	DISTANCIA	6
	7	SANTO DOMINGO 2	42.840	
6	ATZUMBA 2	14.700	PROMEDIO-AVERAGE	TIEMPO TIME
			57.12 KM/H	00:45

DISTANCIA		DIRECCIÓN DIRECTION	PAV	INFORMACIÓN INFORMATION	DIST. REG. TO GO
TOTAL	PARCIAL				
10.700	0.300			LARGA	32.140
12.450	1.750			CONTROL "B" BARDA DE PIEDRA L.D. 18°10'02.3"N 97°34'24.8"W	30.390
12.650	0.200			!	30.190
12.950	0.300			CONTROL "C" MARCA EN PISO CAMINO L.D.	29.890
17.070	4.120			1 ! 2 !!	25.770

DISTANCIA A LA PRÓXIMA INSTRUCCIÓN	0.510
------------------------------------	-------

SS TC TC CH	6	ATZUMBA 2	DISTANCIA	6
	7	SANTO DOMINGO 2	42.840	
6	ATZUMBA 2	14.700	PROMEDIO-AVERAGE	TIEMPO TIME
			57.12 KM/H	00:45

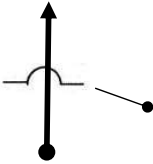
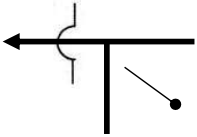
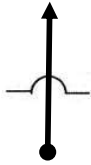
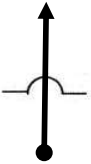
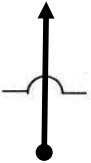
DISTANCIA		DIRECCIÓN DIRECTION	PAV	INFORMACIÓN INFORMATION	DIST. REG. TO GO
TOTAL	PARCIAL				
17.580	0.510			TOPES (2)	25.260
		22			
17.840	0.260			A LA IZQUIERDA Y TOPE	25.000
		23			
17.960	0.120			TOPES (2)	24.880
		24			
19.250	1.290			TOPE	23.590
		25			
19.770	0.520			TOPE	23.070
		26			



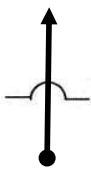
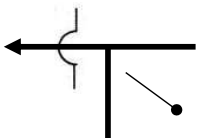
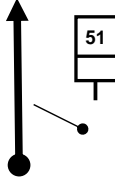
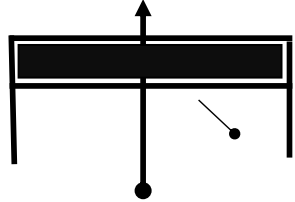
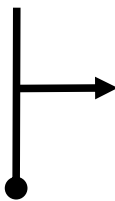

DISTANCIA A LA PRÓXIMA INSTRUCCIÓN	2.120
------------------------------------	-------

SS TC TC CH	6	ATZUMBA 2	DISTANCIA	6
	7	SANTO DOMINGO 2	42.840	
6	ATZUMBA 2	14.700	PROMEDIO-AVERAGE	TIEMPO TIME 00:45
			57.12 KM/H	

DISTANCIA		DIRECCIÓN DIRECTION	PAV	INFORMACIÓN INFORMATION	DIST. REG. TO GO
TOTAL	PARCIAL				
21.890	2.120			TOPES (3)	20.950
		16			
22.120	0.230			A LA IZQUIERDA POR CARRETERA FEDERAL Y TOPE.	20.720
		17			
25.220	3.100			KM 51	17.620
		18			
30.070	4.850			LETRERO ELEVADO "OAXACA"	12.770
		19	-4.850		
35.490	5.420			POR LA DERECHA A OLLERAS DE BUSTAMENTE PRECAUCION	7.350
		20	-10.270		

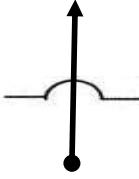
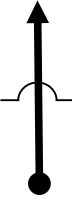
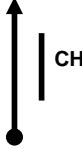

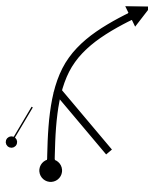
DISTANCIA A LA PRÓXIMA INSTRUCCIÓN	0.180
------------------------------------	-------

SS TC TC CH	6	ATZUMBA 2	DISTANCIA	6
	7	SANTO DOMINGO 2	42.840	
6	ATZUMBA 2	14.700	PROMEDIO-AVERAGE	TIEMPO TIME
			57.12 KM/H	00:45

DISTANCIA		DIRECCIÓN DIRECTION	PAV	INFORMACIÓN INFORMATION	DIST. REG. TO GO
TOTAL	PARCIAL				
37.870	2.380			TOPES (3)	4.970
		16			
42.070	4.200			TOPE (4) POBLACION OLLERAS DE BUSTAMANTE	0.770
		17			
42.790	0.720			 CONTROL "CH" MARCA EN PISO L.D.	0.050
		18			
42.840	0.050			 CONTROL "A" MARCA EN PISO L.D. 18°13.343 N 097°42.797 W	

DISTANCIA A LA PRÓXIMA INSTRUCCIÓN	0.000
------------------------------------	-------

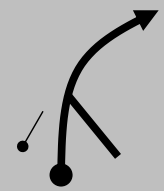
SS TC TC CH	7	SANTO DOMINGO 2	DISTANCIA	7	
	7B	SERVICIO B	16.500		
7	SANTO DOMINGO 2		14.700	PROMEDIO-AVERAGE	TIEMPO TIME
				49.5 Km/h	00:20

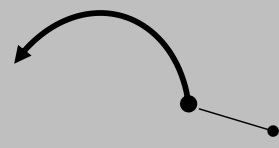
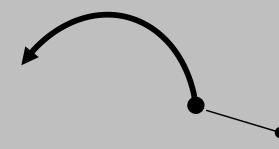
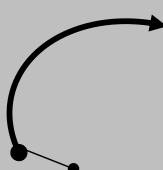
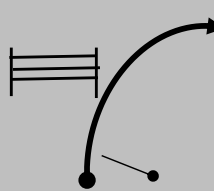
DISTANCIA		DIRECCIÓN DIRECTION	PAV	INFORMACIÓN INFORMATION	DIST. REG. TO GO
TOTAL	PARCIAL				
0.000	0.000			 CONTROL "A" MARCA EN PISO L.D. 18°13.343'N 097°42.797'W	16.500
		1 14.700			
0.540	0.540			!!	15.960
		2 14.160			
0.890	0.350			!!	15.610
		3 13.810			
2.700	1.810			!	13.800
		4 12.000			
3.550	0.850			EN LOMO CON GUARDA GANADO	12.950
		5 11.150			



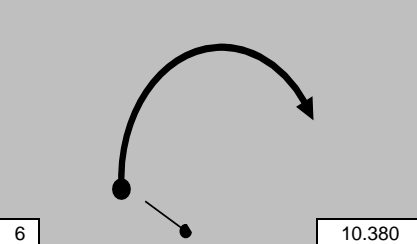
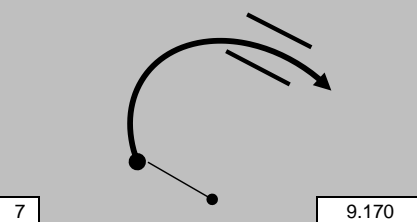
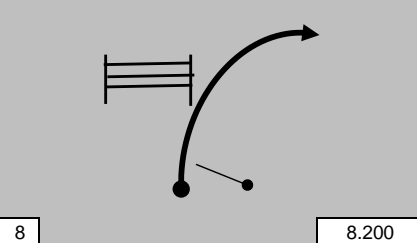
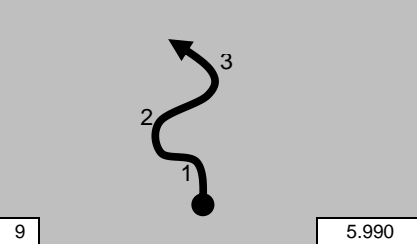
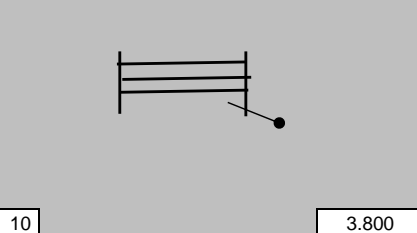

DISTANCIA A LA PRÓXIMA INSTRUCCIÓN	0.770
------------------------------------	-------

SS TC TC CH	7	SANTO DOMINGO 2	DISTANCIA	7		
	7B	SERVICIO B	16.500			
7	SANTO DOMINGO 2		14.700	PROMEDIO-AVERAGE	TIEMPO TIME	00:20
				49.5 Km/h		

DISTANCIA		DIRECCIÓN DIRECTION	P.V.	INFORMACIÓN INFORMATION	DIST. REG. TO GO
TOTAL	PARCIAL				
4.320	0.770			!!	12.180
5.530	1.210			!! y PUENTE	10.970
6.500	0.970			EN LOMO CON GUARDA GANADO	10.000
8.710	2.210			1 ! 2 !! 3 !!	7.790
10.900	2.190			GUARDA GANADO	5.600

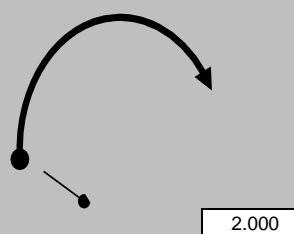
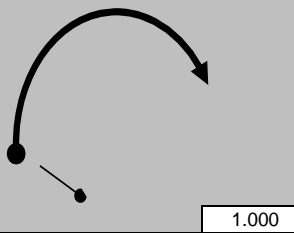
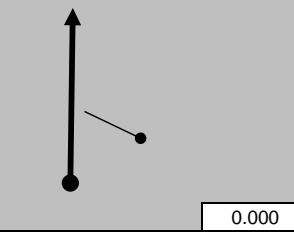

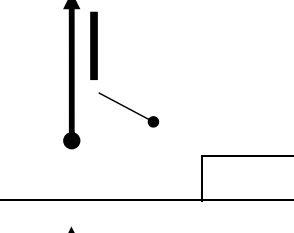
DISTANCIA A LA PRÓXIMA INSTRUCCIÓN	1.800
------------------------------------	-------

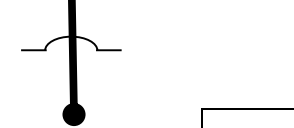
SS TC TC CH	7	SANTO DOMINGO 2	DISTANCIA		7	
	7B	SERVICIO B	16.500			
7	SANTO DOMINGO 2		14.700	PROMEDIO-AVERAGE		
				49.5 Km/h	TIEMPO TIME	00:20

DISTANCIA		DIRECCIÓN DIRECTION	PAV	INFORMACIÓN INFORMATION	DIST. REG. TO GO
TOTAL	PARCIAL				
12.700	1.800	 11 2.000		!!! LARGA	3.800
13.700	1.000	 12 1.000		!!	2.800
14.700	1.000	 13 0.000		 CONTROL "B" FRENTE A REJA ROJA L.I. 18°16'17.3"N 97°47'37.9"W	1.800
15.200	0.500	 14		 CONTROL "C" MARCA EN INICIO DE BANQUETA L.D.	1.300
15.300	0.100	 15		TOPE (4)	1.200

DISTANCIA A LA PRÓXIMA INSTRUCCIÓN	0.600
------------------------------------	-------

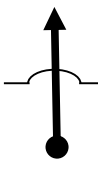
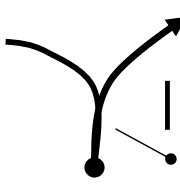
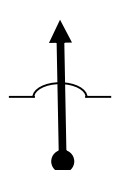
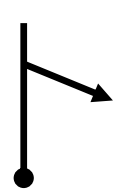
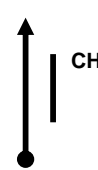
SS TC TC CH	7	SANTO DOMINGO 2	DISTANCIA		7
	7B	SERVICIO B	16.500		
7	SANTO DOMINGO 2		14.700	PROMEDIO-AVERAGE	TIEMPO TIME
				49.5 Km/h	

DISTANCIA		DIRECCIÓN DIRECTION	PAV	INFORMACIÓN INFORMATION	DIST. REG. TO GO
TOTAL	PARCIAL				
15.900	0.600			TOPE (4)	0.600
16.290	0.390			POR LA DERECHA FRENTE A IGLESIA COMIENZA CALLE DE CEMENTO	0.210
16.320	0.030			TOPE	0.180
16.390	0.070			POR LA DERECHA FRENTE A TIENDA EL RUBI	0.110
16.500	0.110			 CONTROL "CH" Entrada a SERVICIO	0.000

DISTANCIA A LA PRÓXIMA INSTRUCCIÓN	0.000
------------------------------------	-------

16°. RALLY SIERRAS DEL SUR

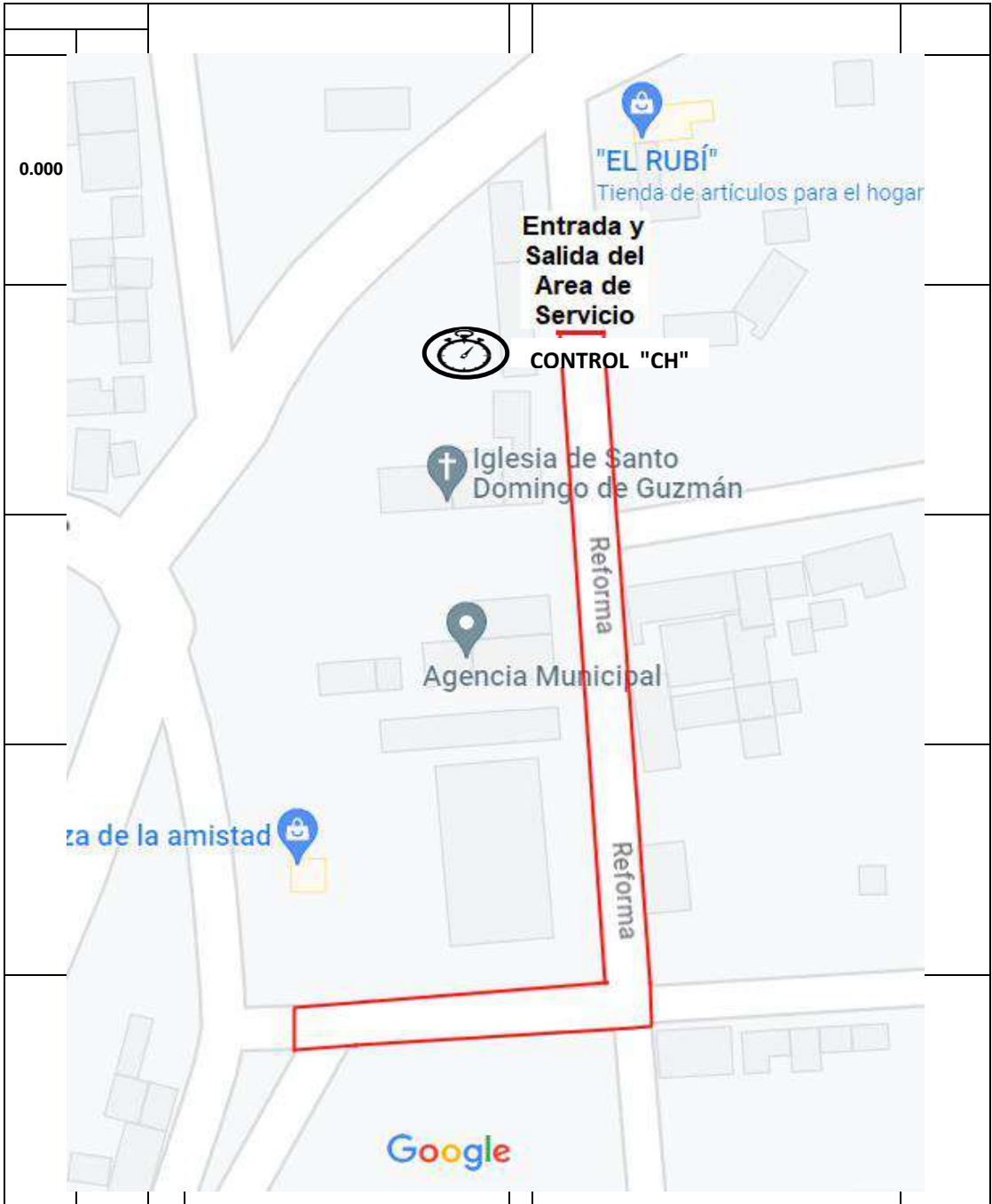

www.cnrm.com.mx

7A	SERVICIO B	0.000 Km.	7A
	SANTO DOMINGO		
			TIEMPO TIME 00:45



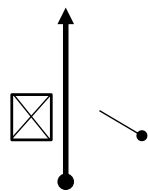
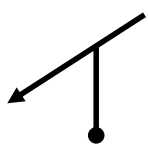
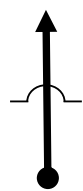

DISTANCIA A LA PRÓXIMA INSTRUCCIÓN	0.000
------------------------------------	-------

SS TC TC CH	7B	SERVICIO B	DISTANCIA	7B
	7C	RECLASIFICACIÓN	0.180	
			PROMEDIO-AVERAGE	TIEMPO TIME 00:00
			0.180 46 KM/H	

DISTANCIA		DIRECCIÓN DIRECTION	PAV	INFORMACIÓN INFORMATION	DIST. REG. TO GO
TOTAL	PARCIAL				
0.000	0.000			DE FRENTE	0.180
		1			
0.110	0.110			POR LA IZQUIERDA	0.070
		2			
0.180	0.070			 CONTROL "CH" TOPE ENTRADA A RECLASIFICACION	0.000
		3			
		4			
		5			

DISTANCIA A LA PRÓXIMA INSTRUCCIÓN 1.920

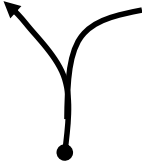
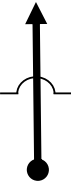
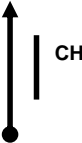
SS TC TC CH	3A	SERVICIO	DISTANCIA	7C
	3B	RECLASIFICACIÓN	2.020	
			2.020	PROMEDIO-AVERAGE
			46 KM/H	TIEMPO TIME 00:03

DISTANCIA		DIRECCIÓN DIRECTION	PAV	INFORMACIÓN INFORMATION	DIST. REG. TO GO
TOTAL	PARCIAL				
0.000	0.000			SALIDA DE RECLASIFICACION POR LA IZQUIERDA	2.200
		1			
0.100	0.100			TOPE (8)	2.100
		2			
2.020	1.920			 CONTROL "CH" MARCA EN PISO L.D.	0.180
		3			
		4			
		5			

DISTANCIA A LA PRÓXIMA INSTRUCCIÓN 1.920

SS TC TC CH	8	OLLERAS 2	DISTANCIA		8
	8A	META EN McCARTHY'S TEHUACAN	81.240		
8	OLLERAS 2		15.500	PROMEDIO-AVERAGE	TIEMPO TIME
				59.29 KM/H	

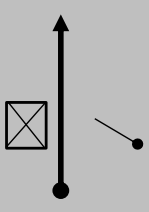
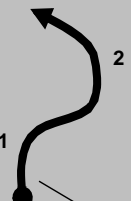
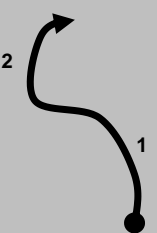
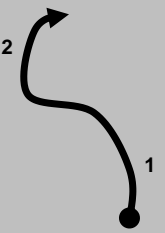
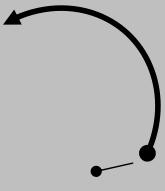
DISTANCIA		DIRECCIÓN DIRECCION	PAV	INFORMACIÓN INFORMATION	DIST. REG. TO GO
TOTAL	PARCIAL				
0.000	0.000			CONTROL "A" MARCA EN PISO LADO DERECHO 18°16.443'N 97°47.711'W	81.240
0.870	0.870			1 ! 2 !!	80.370
1.100	0.230			1 !! LARGA 2 !	80.140
1.840	0.740			1 ! 2 !	79.400
2.200	0.360			!! LARGA	79.040

DISTANCIA A LA PRÓXIMA INSTRUCCIÓN	0.640
------------------------------------	-------

SS TC TC CH	8	OLLERAS 2	DISTANCIA	8
	8A	META EN MCCARTHY'S TEHUACAN	81.240	
8	OLLERAS 2	15.500	PROMEDIO-AVERAGE	TIEMPO TIME
			59.29 KM/H	01:20

DISTANCIA		DIRECCIÓN DIRECTION	PAV	INFORMACIÓN INFORMATION	DIST. REG. TO GO
TOTAL	PARCIAL				
2.840	0.640			LOMO IZQUIERDA !	78.400
		6 12.660			
3.400	0.560			LOMO IZQUIERDA LARGA	77.840
		7 12.100			
3.710	0.310			KM 18	77.530
		8 11.790			
3.900	0.190			!! LARGA	77.340
		9 11.600			
4.250	0.350			GUARDA GANADO	76.990
		10 11.250			

DISTANCIA A LA PRÓXIMA INSTRUCCIÓN 1.050

SS TC TC CH	8	OLLERAS 2	DISTANCIA	8
	8A	META EN McCARTHY'S TEHUACAN	81.240	
8	OLLERAS 2	15.500	PROMEDIO-AVERAGE	TIEMPO TIME
			59.29 KM/H	01:20

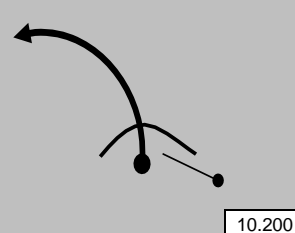
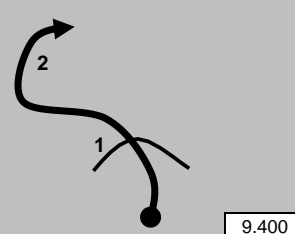
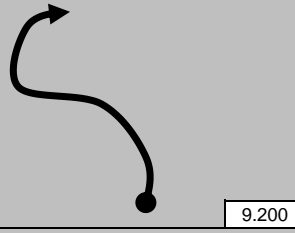
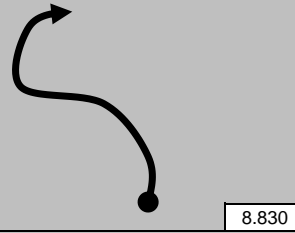
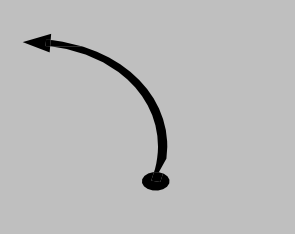
DISTANCIA		DIRECCIÓN DIRECTION	P.V.	INFORMACIÓN INFORMATION	DIST. REG. TO GO
TOTAL	PARCIAL				
5.300	1.050			LOMO IZQ !	75.940
		11 10.200			
6.100	0.800			LOMO 1 ! 2 !!	75.140
		12 9.400			
6.300	0.200			1 ! 2 !!	74.940
		13 9.200			
6.670	0.370			1 ! 2 !!	74.570
		14 8.830			
6.850	0.180			!!	74.390
		15 8.650			

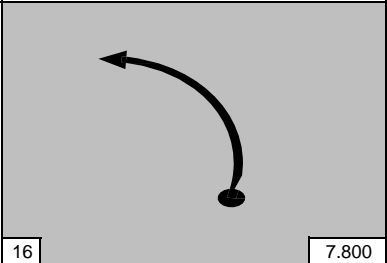
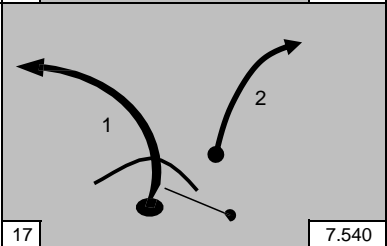
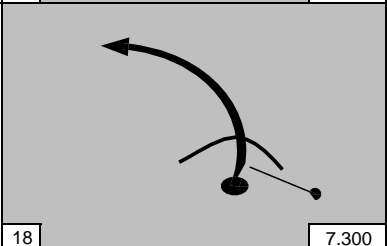
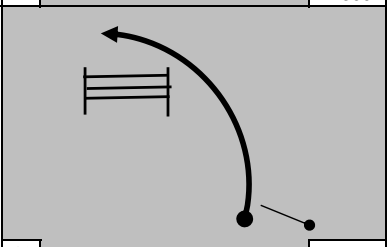
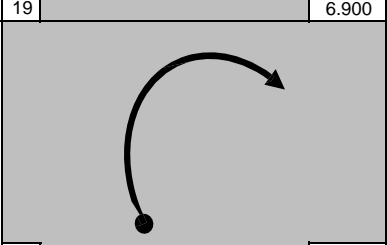

DISTANCIA A LA PRÓXIMA INSTRUCCIÓN	0.850
------------------------------------	-------

SS TC TC CH	8	OLLERAS 2	DISTANCIA	8
	8A	META EN McCARTHY'S TEHUACAN	81.240	
8	OLLERAS 2	15.500	PROMEDIO-AVERAGE	TIEMPO TIME 01:20
			59.29 KM/H	

DISTANCIA		DIRECCIÓN DIRECTION	P.V.	INFORMACIÓN INFORMATION	DIST. REG. TO GO
TOTAL	PARCIAL				
7.700	0.850			!	73.540
7.960	0.260			LOMO IZQUIERDA, DERECHA	73.280
8.200	0.240			IZQUIERDA EN LOMO	73.040
8.600	0.400			GUARDA GANADO EN LOMO IZQUIERDA	72.640
9.270	0.670			!!	71.970



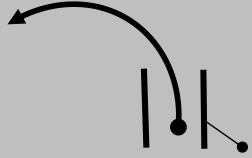

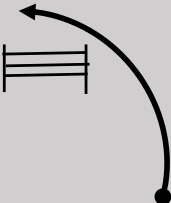
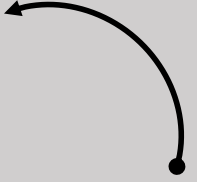
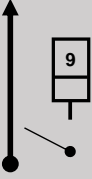
DISTANCIA A LA PRÓXIMA INSTRUCCIÓN 0.230

SS TC TC CH	8	OLLERAS 2	DISTANCIA	8
	8A	META EN McCARTHY'S TEHUACAN	81.240	
8	OLLERAS 2	15.500	PROMEDIO-AVERAGE	TIEMPO TIME 01:20
			59.29 KM/H	

DISTANCIA		DIRECCIÓN DIRECCION	P.V.	INFORMACIÓN INFORMATION	DIST. REG. TO GO
TOTAL	PARCIAL				
9.500	0.230			PUENTE IZQ !!	71.740
		21 6.000			
10.800	1.300			!!	70.440
		22 4.700			
11.600	0.800			IZQ EN LOMO CON GUARDA GANADO	69.640
		23 3.900			
11.800	0.200			!!	69.440
		24 3.700			
12.900	1.100			KM 9	68.340
		25 2.600			

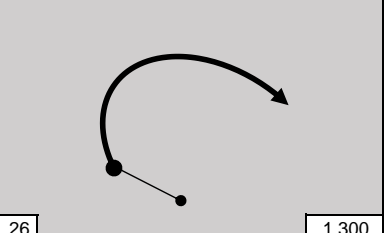
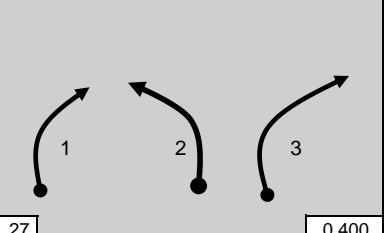
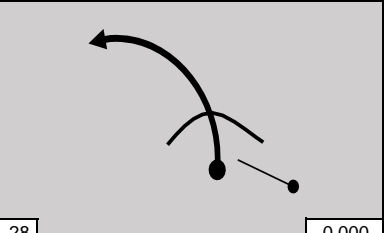
DISTANCIA A LA PRÓXIMA INSTRUCCIÓN	1.300
------------------------------------	-------

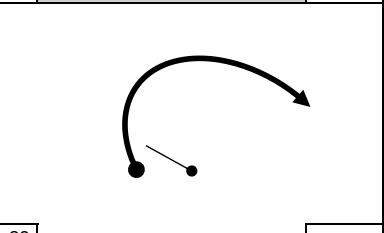
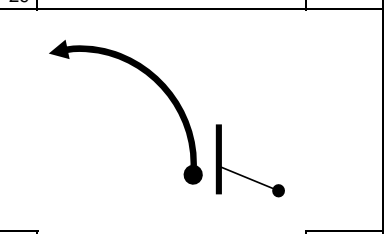
SS TC TC CH	8	OLLERAS 2	DISTANCIA	8	
	8A	META EN McCARTHY'S TEHUACAN	81.240		
8	OLLERAS 2		15.500	PROMEDIO-AVERAGE	
				59.29 KM/H	TIEMPO TIME 01:20

DISTANCIA		DIRECCIÓN DIRECTION	P.V.	INFORMACIÓN INFORMATION	DIST. REG. TO GO
TOTAL	PARCIAL				
14.200	1.300			!!!	67.040
15.100	0.900			1 ! 2 !! 3!!	66.140
15.500	0.400			 CONTROL "B" CONTROL B LOMO IZQ 18°13.265'N 97°42.717'W	65.740
15.600	0.100			!!!	65.640
15.900	0.300			 CONTROL "C" CAMINO DE CEMENTO L.D. MARCA EN PISO L.D.	65.340

DISTANCIA A LA PRÓXIMA INSTRUCCIÓN	0.200
------------------------------------	-------

SS TC TC CH	8	OLLERAS 2	DISTANCIA		8
	8A	META EN McCARTHY'S TEHUACAN	81.240		
8	OLLERAS 2		15.500	PROMEDIO-AVERAGE	TIEMPO TIME 01:20
				59.29 KM/H	

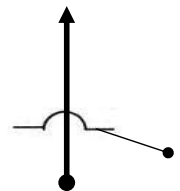
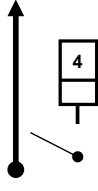
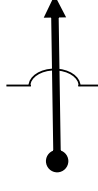
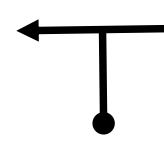
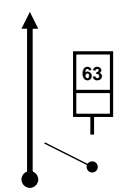
DISTANCIA		DIRECCIÓN DIRECCION	PAV	INFORMACIÓN INFORMATION	DIST. REG. TO GO
TOTAL	PARCIAL				
16.100	0.200			TOPES (4) POBLACIÓN OLLERAS	65.140
		31			
17.800	1.700			KM 4	63.440
		32			
20.400	2.600			TOPES (3)	60.840
		33			
21.800	1.400			POR LA IZQUIERDA SOBRE CARRETERA FEDERAL PRECAUCION	59.440
		34			
22.300	0.500			KM 63	58.940
		35			

DISTANCIA A LA PRÓXIMA INSTRUCCIÓN	5.180
------------------------------------	-------

SS TC TC CH	8	OLLERAS 2	DISTANCIA		8
	8A	META EN McCARTHY'S TEHUACAN	81.240		
8	OLLERAS 2		15.500	PROMEDIO-AVERAGE	TIEMPO TIME
				59.29 KM/H	

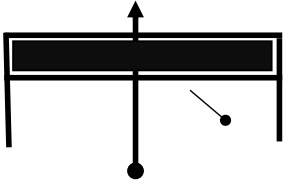
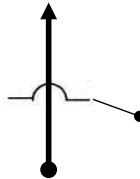
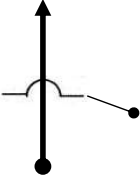
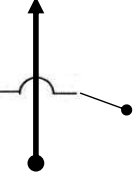
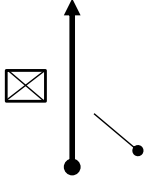
DISTANCIA		DIRECCIÓN DIRECCION	PAV	INFORMACIÓN INFORMATION	DIST. REG. TO GO
TOTAL	PARCIAL				
27.480	5.180			LETRERO ELEVADO "OAXACA"	53.760
		31			
35.470	7.990			TOPES (3) KM 48	45.770
		32			
45.450	9.980			TOPES (3)	35.790
		33			
55.060	9.610			TOPES (5) POBLACIÓN ZAPOTITLAN PRECAUCION	26.180
		34			
56.340	1.280			PEMEX L.I. SE PERMITE RECARGA	24.900
		35			

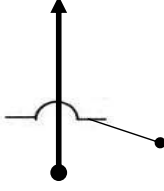
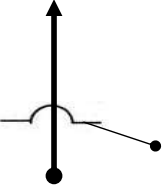
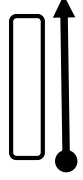
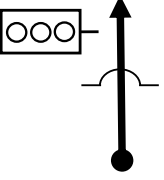
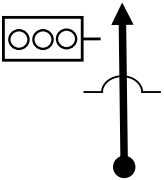

DISTANCIA A LA PRÓXIMA INSTRUCCIÓN	5.150
------------------------------------	-------

SS TC TC CH	8	OLLERAS 2	DISTANCIA	8
	8A	META EN McCARTHY'S TEHUACAN	81.240	
8	OLLERAS 2	15.500	PROMEDIO-AVERAGE	TIEMPO TIME
			59.29 KM/H	01:20

DISTANCIA		DIRECCIÓN DIRECCION	PAV	INFORMACIÓN INFORMATION	DIST. REG. TO GO
TOTAL	PARCIAL				
61.490	5.150			TOPES (2)	19.750
		31			
66.780	5.290			TOPES (4) SAN ANTONIO TEXCALA	14.460
		32			
74.310	7.530			DE FRENTE A TEHUACAN INICIA CAMELLON	6.930
		33			
74.470	0.160			TOPE SEMAFORO DE FRENTE Y TOPES (2)	6.770
		34			
75.140	0.670			TOPE SEMAFORO DE FRENTE	6.100
		35			

DISTANCIA A LA PRÓXIMA INSTRUCCIÓN	0.330
------------------------------------	-------

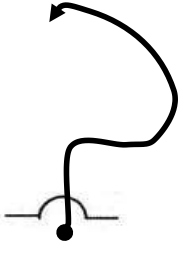
SS TC TC CH	8	OLLERAS 2	DISTANCIA	8
	8A	META EN McCARTHY'S TEHUACAN	81.240	
8	OLLERAS 2	15.500	PROMEDIO-AVERAGE	TIEMPO TIME
			59.29 KM/H	01:20

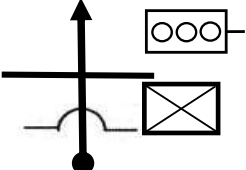
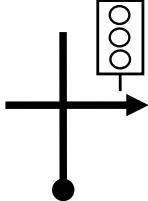
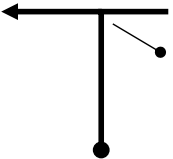
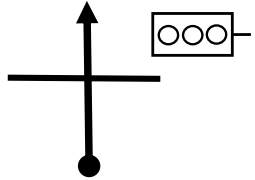
DISTANCIA		DIRECCIÓN DIRECTION	P.V.	INFORMACIÓN INFORMATION	DIST. REG. TO GO
TOTAL	PARCIAL				
75.470	0.330			<p>TOPE Y MONUMENTO SE HARA CARAVANA A LA META</p> <p>NO PENALIZA ADELANTO</p>  <p>CONTROL "CH"</p>	5.770
75.950	0.480			<p>TOPE SEMAFORO DE FRENTE TECNOLÓGICO L.D.</p>	5.290
77.520	1.570			<p>SEMAFORO A LA DERECHA CALLE 17 ORIENTE</p>	3.720
78.090	0.570			<p>A LA IZQUIERDA POR HEROES DE LA INDEPENDENCIA INICIA CAMELLON</p>	3.150
78.210	0.120			<p>SEMAFOROS (2) DE FRENTE</p>	3.030

DISTANCIA A LA PRÓXIMA INSTRUCCIÓN	0.430
------------------------------------	-------

SS TC TC CH	8	OLLERAS 2	DISTANCIA	8
	8A	META EN McCARTHY'S TEHUACAN	81.240	
8	OLLERAS 2	15.500	PROMEDIO-AVERAGE	TIEMPO TIME
			59.29 KM/H	01:20

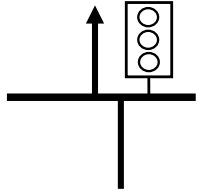
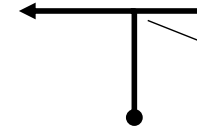
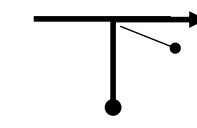
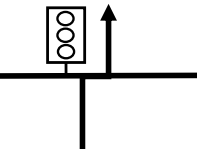
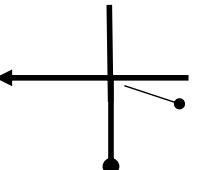
DISTANCIA		DIRECCIÓN DIRECCION	P.V.	INFORMACIÓN INFORMATION	DIST. REG. TO GO
TOTAL	PARCIAL				
78.640	0.430			SEMAFORO IZQUIERDA Y DERECHA PARA SEGUIR DE FRENTE	2.600
		31			
78.790	0.150			SEMAFORO A LA IZQUIERDA POR CALLE 1 ORIENTE	2.450
		32			
78.840	0.050			A LA DERECHA POR CALLE 1 SUR, FRENTE A PORTALES	2.400
		33			
78.920	0.080			SEMAFORO DE FRENTE POR CALLE 1 ORIENTE	2.320
		34			
79.020	0.100			SEMAFORO A LA IZQUIERDA SOBRE CALLE 2 ORIENTE	2.220

DISTANCIA A LA PRÓXIMA INSTRUCCIÓN	0.110
------------------------------------	-------

SS TC TC CH	8	OLLERAS 2	DISTANCIA	8
	8A	META EN McCARTHY'S TEHUACAN	81.240	
8	OLLERAS 2	15.500	PROMEDIO-AVERAGE	TIEMPO TIME
			0	01:20

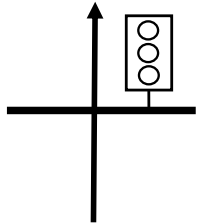
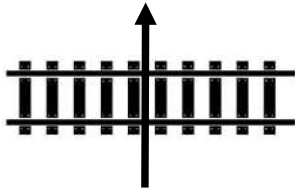
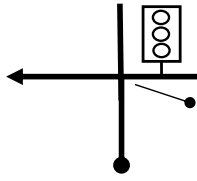
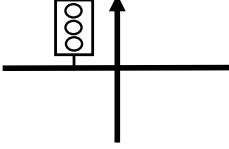
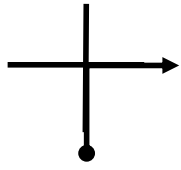
DISTANCIA		DIRECCIÓN DIRECCION	P.V.	INFORMACIÓN INFORMATION	DIST. REG. TO GO
TOTAL	PARCIAL				
79.130	0.110			SEMAFOROS (5) DE FRENTE	2.110
		31			
80.050	0.920			CRUCE DE FERROCARRIL DE FRENTE	1.190
		32			
80.290	0.240			SEMAFORO A LA IZQUIERDA POR CALLE 12 NORTE	0.950
		33			
80.410	0.120			SEMAFOROS (2) DE FRENTE	0.830
		34			
80.600	0.190			A LA DERECHA SOBRE CALLE 1 PONIENTE INICIA CAMELLON	0.640

DISTANCIA A LA PRÓXIMA INSTRUCCIÓN	0.540
------------------------------------	-------

SS TC TC CH	8	OLLERAS 2	DISTANCIA	8
	8A	META EN McCARTHY'S TEHUACAN	81.240	
8	OLLERAS 2	15.500	PROMEDIO-AVERAGE	TIEMPO TIME 01:20
			0	

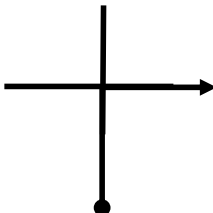
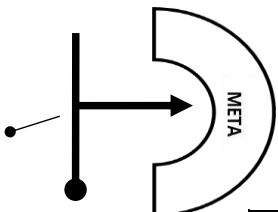
DISTANCIA		DIRECCIÓN DIRECTION	P.V.	INFORMACIÓN INFORMATION	DIST. REG. TO GO
TOTAL	PARCIAL				
81.140	0.540			A LA DERECHA SOBRE LATERAL DE ENRIQUE MONT SOLORZANO	0.100
		31			
81.240	0.100			A LA DERECHA FRENTE A McCARTHYS META	0.000
		32			

DISTANCIA A LA PRÓXIMA INSTRUCCIÓN 0.000

ABANDONO

Nombre: _____
No. auto: _____

Numero de TC:
Referencia:

Causa de abandono:

Firma del competidor

Barredora

HOJA DE EVALUACION

Piloto: _____

Navegante: _____

No. de auto: _____

Calificación (1 = Excelente, 5 = Muy malo)	1	2	3	4	5
Documentación general					
Reglamento particular					
Boletines					
Promoción general					
Presentación					
Página de Internet					
Ruta generalidad					
Libreta de ruta					
Estado de los tramos					
Oficiales					
Escrutinadores					
Controles					
Funcionamiento					
Presentación					
VPI					
Jueces de hechos					
Puestos de radio					
Tren de carrera					
Seguridad					
Cierre de tramos					
Ambulancias					
Arrancada					
Meta Final					

Observaciones:

PROTESTA

Protestante:

Nombre: _____
No. auto: _____
Tel. de contacto: _____

Protestado:

Nombre: _____
No. auto: _____

Tipo: Pesos

Convencional:	2,000.00	<input type="checkbox"/>
Motor / tren motriz	4,000.00	<input type="checkbox"/>

Observaciones:

Firma del protestante

Firma del comisario

Hora de recepción

es

o

es